United States
Department of
Agriculture

**Natural
Resources
Conservation
Service**

**Part 637 Environmental Engineering
National Engineering Handbook**

Chapter 2 Composting

Issued February 2000

The United States Department of Agriculture (USDA) prohibits discrimination in all its programs and activities on the basis of race, color, national origin, gender, religion, age, disability, political beliefs, sexual orientation, and marital or family status. (Not all prohibited bases apply to all programs.) Persons with disabilities who require alternative means for communication of program information (Braille, large print, audiotape, etc.) should contact USDA's TARGET Center at (202) 720-2600 (voice and TDD).

To file a complaint, write USDA, Director, Office of Civil Rights, Room 326W, Whitten Building, 14th and Independence Avenue, SW, Washington, DC 20250-9410 or call (202)720-5964 (voice or TDD). USDA is an equal employment opportunity provider and employer.

Acknowledgments

Chapter 2, Composting, was prepared by **Robert E. Graves**, professor, Agricultural and Biological Engineering Department, The Pennsylvania State University, and **Gwendolyn M. Hattemer**, engineering project associate, Agricultural and Biological Engineering Department, The Pennsylvania State University. **Donald Stettler**, environmental engineer, Natural Resources Conservation Service, National Water and Climate Center, Portland, Oregon, coordinated the project. This project was originally conceived by **James N. Krider**, national environmental engineer, NRCS, Washington, DC (retired) working with **Dana Chapman** of The Pennsylvania State University and NRCS (retired).

The major NRCS participants in the review of this document from its inception were **Barry Kitzner**, national environmental engineer, Washington, DC, **David C. Moffitt**, water quality specialist, Fort Worth, Texas; **Victor W.E. Payne** (retired), and **Frank Geter** (retired).

The final edit, graphic production, and publication formatting were provided by **Mary R. Mattinson**, editor; **Wendy Pierce**, illustrator; and **Suzi Self**, editorial assistant, NRCS National Production Services, Fort Worth, Texas.

Chapter 2

Composting

Contents:	637.0200 Introduction	2-1
	(a) Definition of composting	2-1
	(b) Composting in the United States	2-1
	(c) General procedure	2-1
	637.0201 Principles of composting	2-2
	(a) General background	2-2
	(b) Composting process	2-2
	(c) Microbiology	2-4
	(d) Chemical transformations	2-6
	637.0202 Design of compost mixtures	2-11
	(a) Components of compost mix	2-11
	(b) Typical raw material	2-12
	(c) Determination of the compost recipe	2-13
	637.0203 Monitoring and parameter adjustment	2-17
	(a) Temperature	2-17
	(b) Odor management	2-18
	(c) Moisture	2-18
	(d) Oxygen and carbon dioxide	2-19
	(e) Monitoring equipment	2-19
	637.0204 Odor generation	2-20
	637.0205 Additives, inoculums, starters	2-21
	637.0206 Pathogens	2-22
	637.0207—Health risks of a composting operation	2-24
	(a) Bioaerosols	2-24
	637.0208 Aeration requirements	2-25

637.0209—Analysis of raw materials and compost	2-28
(a) Determining moisture content	2-29
(b) Bulk density	2-30
(c) pH and soluble salts	2-30
(d) Particle size distribution	2-31
(e) Organic matter content	2-31
(f) Substrate degradability	2-31
(g) Compost quality	2-31
(h) Determination of compost stability	2-33
<hr/>	
637.0210 Composting methods	2-36
(a) Passive composting piles	2-36
(b) Windrow	2-37
(c) Passively aerated windrows	2-37
(d) Aerated static pile	2-38
(e) In-vessel systems	2-39
(f) Comparison of composting methods	2-40
(g) Controlled microbial composting	2-42
<hr/>	
637.0211 Dead animal composting	2-44
(a) General	2-44
(b) Dead poultry and small animal composting	2-46
(c) Dead swine and large animal composting	2-47
<hr/>	
637.0212 Operational costs	2-50
(a) Availability and price of raw material	2-50
(b) Quantity and price of land available for the composting operation	2-50
(c) Estimated costs of operation/production	2-50
(d) Pre-startup cost	2-51
(e) Material handling	2-51
(f) Monitoring	2-51
(g) Operations after completion of composting	2-51
<hr/>	
637.0213 Compost end use	2-52
(a) Land application	2-52
(b) Marketing considerations	2-53
<hr/>	
637.0213 References	2-54
<hr/>	
Glossary	2-59

Appendixes

Appendix 2A Common Raw Materials for Farm Composting	2A-1
Appendix 2B Testing Material on the Farm	2B-1

Tables

Table 2-1	Dewar self-heating method for determining compost maturity	2-34
Table 2-2	Stability of compost based on carbon dioxide respired during incubation	2-34
Table 2-3	Volatile organic acids as an indicator of compost instability	2-35
Table 2-4	Phytotoxicity as an indicator of compost stability	2-35
Table 2-5	Mortality rates and design carcass weights for determining the size of a dead swine composting facility	2-47
Table 2-6	Mix for composting dead swine with sawdust	2-48
Table 2-7	Mix for composting dead swine with broiler litter using sawdust/straw as a carbon source and bulking agent	2-48

Figures

Figure 2-1	Compost temperature ranges	2-2
Figure 2-2	Bacteria	2-4
Figure 2-3	Fungi	2-5
Figure 2-4	Actinomycetes	2-5
Figure 2-5	Higher organisms	2-5
Figure 2-6	Passive compost pile	2-36
Figure 2-7	Windrow method	2-37
Figure 2-8	Passive aerated windrow	2-38

Figure 2-9	Aerated static pile	2-38
Figure 2-10	Bin	2-39
Figure 2-11	Rectangular agitated bed system	2-39
Figure 2-12	In-vessel silo	2-39
Figure 2-13	Rotating tube composter	2-40
Figure 2-14	Dead bird composter	2-45
Figure 2-15	Dead bird bin composting schematic	2-45

Examples	Example 2-1	Determining the proportion of materials needed to develop a mix based on the C:N ratio	2-14
	Example 2-2	Determining the size of a dead swine composting facility	2-49

637.0200 Introduction

(a) Definition of composting

Composting is the controlled aerobic biological decomposition of organic matter into a stable, humus-like product called compost. It is essentially the same process as natural decomposition except that it is enhanced and accelerated by mixing organic waste with other ingredients to optimize microbial growth.

The potential benefits of composting manure and other organic wastes are improved manure handling; reduced odor, fly, and other vector problems; and reduced weed seeds and pathogens. Land applied compost improves soil fertility, tilth, and water holding capacity. It is also free of offensive odors and can be stored for extended periods. These qualities make it suitable for use on the farm or for sale.

Composting is easily adapted to agricultural operations because farms generally produce suitable amounts and types of waste for composting, have adequate land, will benefit from the application of compost to the soil, and have the necessary equipment already available.

(b) Composting in the United States

Composting is more prevalent in the United States in response to concerns about agricultural pollution and the encroachment of the urban population in rural areas. The availability of cost-sharing to fund composting facilities, particularly in some critical watersheds, has also driven the growth of composting.

The Natural Resources Conservation Service helps farmers to design composting facilities as a part of a waste management system. Composting is used as a treatment component to convert manure and other organic material into a more environmentally stable product.

Composting is an alternative to more commonly used methods of managing manure and other organic wastes, such as poultry or livestock mortalities and

crop residue. It provides a means of developing an organic source of fertilizer or soil conditioner. Because composting is suited to a wide range of materials, it is possible for a composting operation to work in cooperation with other farms, municipalities, and industry to compost their organic wastes, such as manure from horse race tracks, food processing wastes, or yard trimmings.

(c) General procedure

The principal elements in planning a compost facility include performing site investigations and developing the recipe design, facility design, waste utilization plan, and an operation and maintenance plan. Because composting is a relatively flexible process, it is necessary to decide among alternative methods, locations, and materials. The decision depends on the management and economic aspects of the farm as well as on the physical limitations of the site. The planner needs to present the landowner with the different alternatives so that the owner can make the final decision.

637.0201 Principles of composting

(a) General background

Composting is the process by which various aerobic micro-organisms decompose raw organic material to obtain energy and material they need for growth and reproduction. The stable by-products of this decomposition, the biomass of both dead and living micro-organisms, and the undegradable parts of the raw material make up the end product that is called compost.

The organisms responsible for composting require certain nutritional and environmental conditions to survive and function. They require adequate amounts of macro- and micro-nutrients, oxygen, and water. These organisms experience optimal growth rates only within certain temperature and pH ranges.

(b) Composting process

The composting process is carried out by a diverse population of predominantly aerobic micro-organisms that decompose organic material in order to grow and reproduce. The activity of these micro-organisms is encouraged through management of the carbon-to-nitrogen (C:N) ratio, oxygen supply, moisture content, temperature, and pH of the compost pile. Properly managed composting increases the rate of natural decomposition and generates sufficient heat to destroy weed seeds, pathogens, and fly larvae.

The composting process can be divided into two main periods: (1) active composting and (2) curing. **Active composting** is the period of vigorous microbial activity during which readily degradable material is decomposed as well as some of the more decay-resistant material, such as cellulose. **Curing** follows active composting and is characterized by a lower level of microbial activity and the further decomposition of the products of the active composting stage. When curing has reached its final stage, the compost is said to be stabilized.

The compost pile passes through a wide range of temperatures over the course of the active composting period. As the temperature varies, conditions become unsuitable for some micro-organisms while at the same time become ideal for others. The active composting period has three temperature ranges. These ranges are defined by the types of micro-organisms that dominate the pile during those temperatures (fig. 2-1) and are called psychrophilic, mesophilic, and thermophilic. **Psychrophilic** temperatures are generally defined as those below 50 degrees Fahrenheit, **mesophilic** between 50 and 105 degrees Fahrenheit, and **thermophilic** above 105 degrees Fahrenheit.

Defining these temperature ranges does not mean micro-organisms found in the pile during the mesophilic stage are not found during the psychrophilic or thermophilic stage. Rather, these ranges are defined to make a rough delineation between temperatures at which certain classes of micro-organisms have peak growth rates and efficiencies. For example, mesophilic organisms may inhabit the pile in the thermophilic or psychrophilic temperature ranges, but will not dominate the microbial population because they are not functioning at optimal levels.

The initial stage of composting is marked by either psychrophilic or mesophilic temperatures depending on the ambient temperature and the temperatures of the compost mix material. A short lag period is typical at the start of the composting process before the temperature begins to rise rapidly. This lag period is

Figure 2-1 Compost temperature ranges

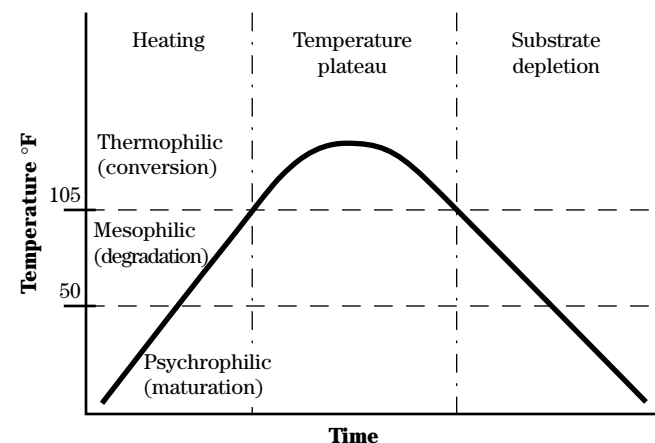

the time necessary for the development of the microbial population. As the microbial population begins to degrade the most readily degradable material and the population increases, the heat generated by the microbial activity is trapped by the self-insulating compost material. As the heat within the pile accumulates, the temperature of the compost pile begins to rise. The temperature continues to increase steadily through the psychrophilic and mesophilic temperature ranges as the microbial population increases and diversifies. Depending on the operation, the compost pile typically takes from 2 to 3 days to increase beyond mesophilic temperatures and reach the thermophilic stage of composting.

As the pile temperatures increase into the thermophilic range, the pile becomes inhabited by a diverse population of micro-organisms operating at peak growth and efficiency. This intense microbial activity sustains the vigorous heating that is necessary for the destruction of pathogens, fly larvae, and weed seeds. The diversity of the microbial population also allows the decomposition of a wide range of material from simple, easily degradable material to more complex, decay resistant matter, such as cellulose.

The temperatures continue to rise and peak at about 130 to 160 degrees Fahrenheit. Once this peak is reached, microbial activity begins to decrease in response to a depletion in readily degradable material and oxygen or to the excessively high temperature that is detrimental to their function. Micro-organisms degrade material by moving soluble components through their body walls as is done for simple compounds or by using extracellular enzymes to break the material down before it is taken into the cell body. If the temperature becomes too high, the enzymes responsible for the breakdown denature and become nonfunctional so that the micro-organisms cannot get the nutrition they need to survive. Elevated temperature may not be lethal for all micro-organisms, but may affect their efficiency and further contribute to the decrease in microbial activity. Still other micro-organisms form spores in response to excessive heating. Spores are the inactive form that some micro-organisms take to protect themselves from conditions adverse to survival, such as heat and lack of moisture. These spores germinate once more favorable conditions return.

As microbial activity decreases, more heat is lost from the pile than is generated, and the pile begins to cool. As the temperature cools from thermophilic levels, different micro-organisms reinhabit the pile by migrating from cooler spots while spores germinate as conditions become more suitable for survival. These micro-organisms serve to continue the decomposition process. The compost pile remains in the thermophilic range from 10 to 60 days, depending on the operation. Once the temperature decreases to below 105 degrees Fahrenheit, the curing period may begin or the pile may be aerated to reactivate active composting.

At no set point is active composting determined to be complete. It is usually considered complete when the pile conditions are such that microbial activity can not increase enough to reheat the pile. This generally happens when the temperature has decreased to below 105 degrees Fahrenheit. Although microbial activity is not as intense and most of the organic material has already been degraded, curing is an important part of the composting process.

Curing is marked by a lower level of microbial activity and is responsible for stabilizing the products resulting from active composting period. Stabilization includes further decomposition of organic acids and decay-resistant compounds, the formation of humic compounds, and the formation of nitrate-nitrogen. Another benefit of curing is that certain fungi begin to inhabit the pile and contribute to the disease suppressant qualities of the compost. Because microbial activity has decreased and is operating at a lower level, little heat is generated and the pile temperature continues to decrease or remains at a low level. Proper management of moisture and oxygen is still required during the curing period to maintain microbial activity. Management during the curing period is also required to ensure that the pile is not recontaminated with weed seeds. This may require covering or relocating the curing piles to reduce the potential for recontamination.

The reactions that take place during curing are relatively slow and, as such, require adequate time. The length of the curing period varies with the type of operation, the length of the active composting period, and the intended end use of the compost. Short, active composting periods require extended curing periods to allow for sufficient decomposition and stabilization.

Compost that will be used for sensitive end-uses, such as application to sensitive crops or in potting media, also requires an extended curing period. Curing is generally considered complete when the pile after repeated mixings returns to ambient temperature. It is important to distinguish between cooling that is a result of sufficient curing and cooling that is a result of inadequate oxygen supply or moisture content. Curing generally lasts from 1 to 6 months.

(c) Microbiology

A variety of microbial populations develops in response to the different levels of temperature, moisture, oxygen, and pH within a compost pile. This microbial diversity enables the composting process to continue despite the constantly changing environmental and nutritional conditions within the pile. The micro-organisms responsible for composting degrade a broad range of compounds from amino acids and simple sugars to complex proteins and carbohydrates. This results in a thorough degradation of the compost material. Temperature levels and available food supply generally have the greatest influence in determining what class and species of organisms make up the microbial population at a particular time.

Decomposition proceeds rapidly in the initial stages of composting because of the abundant supply of readily degradable material. The material is characterized by a low molecular weight and simple chemical structure. It is water soluble and can pass easily through the cell wall of the organisms, which allows it to be metabolized by a broad range of nonspecialized organisms.

As the readily degradable material is consumed and the supply diminishes, more complex, less degradable material begins to be decomposed. This material is characterized by a high molecular weight, polymeric (long chain) chemical structure that cannot pass directly into the cells. The material must be broken down into smaller components through the action of extracellular enzymes. Not all of the micro-organisms present in the compost pile can produce these enzymes, particularly simple organisms, such as bacteria. Such decomposition requires more specialized organisms, such as fungi. After the polymeric material is hydrolyzed into smaller components by these specialized organisms, the resulting fragments can then be used by the nonspecialized organisms.

Micro-organisms that inhabit a compost pile are in three classes: bacteria, fungi, and actinomycetes, a higher form of bacteria. They can be anaerobes, aerobes, or facultative anaerobes. Strict anaerobes do not use oxygen and will die if exposed to oxygen. Aerobes use oxygen, and facultative anaerobes use oxygen if it is available, but can function without it.

The micro-organisms within a compost pile can be psychrophilic, mesophilic, or thermophilic depending on the temperature range within which they experience optimal growth rates. The psychrophilic temperature range is defined as being below 50 degrees Fahrenheit, mesophilic between 50 and 105 degrees Fahrenheit, and thermophilic between 105 and 160 degrees Fahrenheit.

(1) Bacteria

Bacteria (fig. 2-2) are small, simple organisms present primarily during the early stages of the composting period. They are responsible for much of the initial decomposition and include a wide range of organisms that can survive in many different environmental conditions. Although they are small relative to fungi and actinomycetes, they are present in significantly greater numbers.

Bacteria are fast decomposers. They stabilize most readily available nutrients, such as simple sugars, as well as digest the products of fungal decomposition. Some bacteria can degrade cellulose.

Figure 2-2 Bacteria

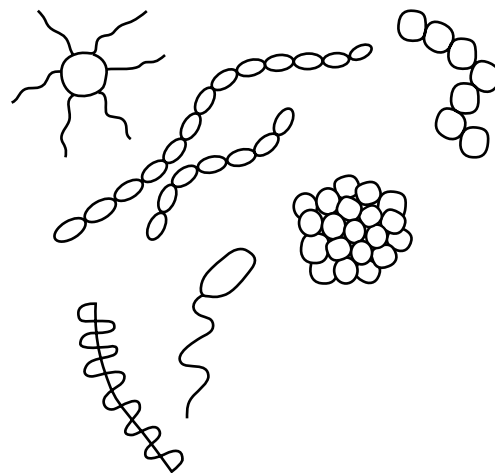

Bacteria function optimally within a pH range of 6 to 7.5 and are less tolerant of low moisture conditions than other types of micro-organisms. Some bacteria form endospores that enable them to withstand unfavorable environmental conditions, such as high temperature or low moisture. When the environment becomes more favorable for survival, the endospores germinate and the bacteria become active again. This feature of certain bacteria helps to continue the composting process during the cooling phase that follows peak thermophilic temperatures.

(2) Fungi

Fungi (fig 2-3) are larger organisms than bacteria. They form networks of individual cells in strands called filaments. Fungi tend to be present in the later stages of composting because of the nature of the material they decompose. Most fungi decay woody substances and other decay-resistant material, such as waxes, proteins, hemicelluloses, lignin, and pectin. Fungi are less sensitive to environments with low moisture and pH than bacteria, but because most fungi are obligate aerobes (require oxygen to grow), they have a lower tolerance for low-oxygen environments than bacteria. Fungi also cannot survive above a temperature of 140 degrees Fahrenheit.

Considering that fungi cannot survive in temperatures greater than 140 degrees Fahrenheit and that they are responsible for much of the decay of resistant material indicates that excessive temperatures are detrimental to the composting process in terms of complete degradation. Therefore, while high temperature levels are desirable for pathogen destruction, they must be controlled to reduce the destruction of beneficial organisms and its subsequent effect on the completion of decomposition.

(3) Actinomycetes

The actinomycetes (fig. 2-4) are the third major class of micro-organisms that inhabit a compost pile. Actinomycetes are technically bacteria because of their structure and size, but are similar to fungi in that they form filaments and are able to use a variety of substrates. Actinomycetes can degrade organic acids, sugars, starches, hemicelluloses, celluloses, proteins, polypeptides, amino acids, and even lignins. They also produce extracellular proteases and can lyse (disintegrate or dissolve) other bacteria. Actinomycetes are more prevalent in the later stages of composting when most of the easily degradable compounds have been

Figure 2-3 Fungi

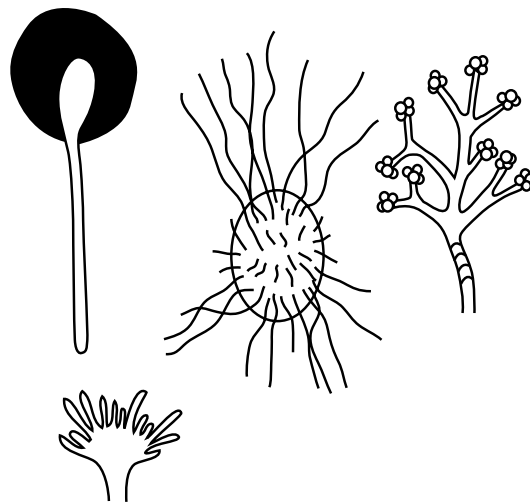

Figure 2-4 Actinomycetes

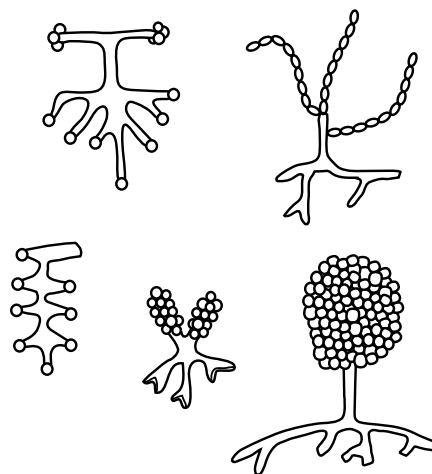
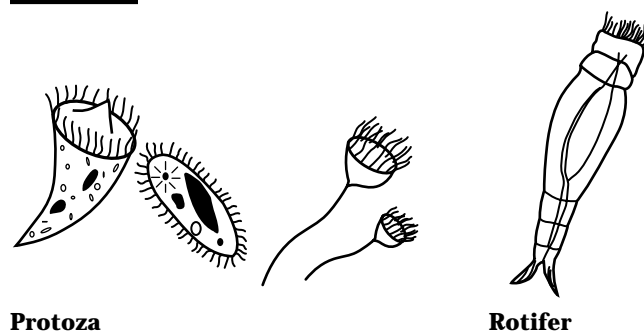

Figure 2-5 Higher organisms



Protozoa

Rotifer

degraded, the moisture levels have decreased, and the pH has become less acidic.

(4) Higher organisms

Higher organisms (fig 2-5) begin to invade the compost pile once the pile temperatures cool to suitable levels. These organisms include protozoa, rotifers, and nematodes. They consume the bacterial and fungal biomass and aid in the degradation of lignins and pectins. These higher organisms contribute to the disease suppressive qualities of the compost.

(d) Chemical transformations

During the composting process, micro-organisms degrade the raw material of the compost mix to synthesize new cellular material and to obtain the energy for these catabolic processes. Several chemical transformations take place as complex compounds are broken down into simpler ones and then synthesized into new complex compounds.

Before the micro-organisms can synthesize new cellular material, they require sufficient energy for these processes. The two possible modes of energy yielding metabolism for heterotrophic micro-organisms are respiration and fermentation.

Respiration can be either aerobic or anaerobic. In aerobic respiration, the aerobic micro-organisms use molecular oxygen, O_2 , to liberate the bulk of the energy from the carbon source, producing carbon dioxide and water in the process (see equation 2-1).

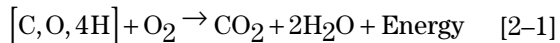

This conversion is not achieved through a single reaction, but through a series of reactions. These reactions serve not only to liberate significant quantities of energy, but also to form a large number of organic intermediates that serve as starting points for other synthetic reactions.

Aerobic respiration is preferred over anaerobic respiration and fermentation for composting because it is more efficient, generates more energy, operates at higher temperatures, and does not produce the same quantity of odorous compounds. Aerobes can also use a greater variety of organic compounds as a source of energy that results in more complete degradation and stabilization of the compost material.

In anaerobic respiration, the micro-organisms use electron acceptors other than O_2 , such as nitrates (NO_3^-), sulfates (SO_4^{2-}), and carbonates (CO_3^{2-}) to obtain energy. Their use of these alternate electron acceptors in the energy-yielding metabolism produces odorous or undesirable compounds, such as hydrogen sulfide (H_2S) and methane (CH_4). Anaerobic respiration also leads to the formation of organic acid intermediates that tend to accumulate and are detrimental to aerobic micro-organisms. Aerobic respiration also forms organic acid intermediates, but these intermediates are readily consumed by subsequent reactions so that they do not pose as significant a potential for odors as in anaerobic respiration.

Fermentation is the simplest means of energy generation. It does not require oxygen and is quite inefficient. Most of the carbon decomposed through fermentation is converted to end-products, not cell constituents, while liberating only a small amount of energy.

Unassimilated protein as nitrogenous organic residue is broken down to obtain the nitrogen necessary for the synthesis of cellular material in heterotrophic micro-organisms. Nitrogenous organic residues, or proteins, undergo enzymatic oxidation (digestion) to form complex amino compounds through a process called aminization. Carbon dioxide (CO_2), energy, and other by-products are also produced.

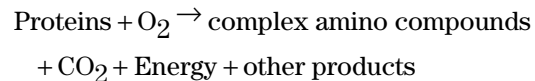

The complex amino compounds formed can then be synthesized into the micro-organisms or undergo additional decomposition into simpler products. The general reduction in complexity of the amino compounds proceeds from proteoses to peptones to amino acids and acid amides (Hansen, et al. 1990).

The products of the digestion of the proteins and complex amino acids can only be used in the synthesis of new cellular material if sufficient carbon is available. If not enough carbon or energy to incorporate these amino compounds into the cells is available, unstable nitrogen forms and accumulates through the process of ammonification (see equation 2-2). Because the ammonia group is characteristic of amino acids, ammonia (NH_3) or ammonium ions (NH_4^+) will accumulate.



The ammonium compound that is formed interconverts between two forms depending on the pH and temperature of the pile. This interconversion between NH_3 and NH_4^+ is described by reaction shown in equation 2-3.

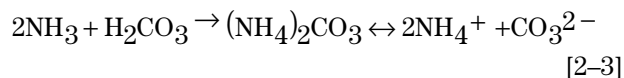

Acidic conditions ($\text{pH} < 7$) promote the formation of NH_4^+ , while basic conditions promote the formation of NH_3 . Elevated temperature also favors the formation of NH_3 and, because of the low vapor pressure of NH_3 , it generally results in gaseous NH_3 emissions from the pile.

Another key chemical transformation of the composting process is nitrification, the process by which ammonia or ammonium ions are oxidized to nitrates. Nitrification is a two-step process. In the first step, $\text{NH}_4^+ - \text{N}$ is oxidized to form nitrites (NO_2^-) through the action of autotrophic bacteria that use the energy produced by this conversion. The nitrites are then rapidly converted to nitrates (NO_3^-) by a different group of micro-organisms called nitrifying bacteria. The reactions are shown in equations 2-4 and 2-5.

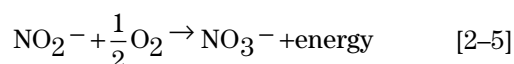
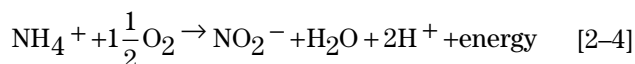

Nitrification occurs during the curing period. Since nitrites (NO_2^-) are toxic to plants and nitrates (NO_3^-) are the form of nitrogen most usable in plant metabolism, enough time must be allowed for the curing period so nitrates are the final nitrogen product in the compost. In addition, because nitrification requires oxygen, proper aeration of the compost pile must be maintained during curing.

Another important nitrogen transformation is denitrification. Denitrification occurs in oxygen-depleted environments. It can be carried out by either aerobic or anaerobic bacteria. If denitrification is carried out by aerobic bacteria, nitrate is being used in place of oxygen as a hydrogen acceptor resulting in the following progression of nitrogen:



If denitrification is carried out by anaerobic bacteria, the general reaction is:

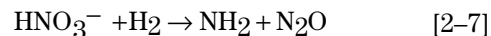

Because nitrous oxide is an odorous compound and results in the loss of beneficial nitrate-nitrogen, denitrification is not desired and can be avoided by maintaining aerobic pile conditions. This, of course, is accomplished with proper aeration.

(1) Nitrogen losses

A significant amount of nitrogen is lost during the composting process. The amount of nitrogen lost, however, varies widely and is somewhat dependent on the material, method, and management methods employed. Martins and Dewes (1992) found average nitrogen losses of 69.2 and 59.6 percent for poultry manure and 53.6 and 57.1 percent for pig and cow manure. Hansen, et al. (1990) found nitrogen losses varying from 3.7 to 32.0 percent when composting poultry manure. Nitrogen losses are a concern because of potential contamination of ground water, odor problems, and final nitrogen content of the compost. If nitrogen conservation is a goal, it is possible to manage the composting operation so the potential for nitrogen losses is reduced.

The three possible pathways for nitrogen losses during the composting process are gaseous emissions, leaching, and denitrification.

The primary path of nutrient losses during composting is through gaseous emissions. Martin and Dewes (1992) found that 46.8 to 77.4 percent of the nitrogen lost was gaseous emissions. The majority of these emissions are ammonia (NH_3) with a small percentage nitrous oxide (N_2O). The most important factors in the release of NH_3 from a compost pile are the pH, ammonium (NH_4^+)/ NH_3 equilibrium, mineralization rates of organic nitrogen compounds, C:N ratio, temperature, and pile aeration. A pH greater than 8 promotes the conversion of NH_4^+ to NH_3 . The release of NH_3 as gaseous ammonia is then promoted by the elevated temperature. Ammonia emissions also increase if nitrogen has accumulated generally in response to a low C:N ratio or nitrogen-rich raw material, such as poultry manure. Turning the compost pile to aerate the pile also influences the release of gaseous emissions. These losses increase as the frequency of turnings increases. Gaseous NH_3 emissions increase after pile turnings because the action of turning the pile releases

any gases that have built up in the pile. In addition, because turning rebuilds porosity and increases pile aeration, it recharges microbial activity so that more NH_3 is produced that is in turn potentially lost.

Leaching nutrient losses are primarily as bound nitrogen, ammonium ions (NH_4^+), and small amounts of nitrates (NO_3^-). Nitrates are a concern because of their potential to contaminate ground water although they have not been found in significant amounts in compost leachate (Rymshaw, et al. 1992). Martin and Dewes (1992) found that 9.6 to 19.6 percent of the total nitrogen was drained off as leachate of which 76.5 to 97.8 percent was ammonium nitrogen (NH_4^+-N) and the rest, 0.1 to 2.2 percent was nitrate nitrogen (NO_3^-).

The greatest amount of leaching occurs during the first 2 weeks of the composting period. Leaching after that time generally occurs after a rainfall if the compost facility is uncovered. The amount of leachate, the nitrogen content of the leachate, and the proportion of nitrogen fractions within the leachate are dependent on a number of interrelated factors. These include the type of material being composted, the point in the active composting process, and the frequency of pile turnings. The amount of nitrogen lost as leachate is greater for the material rich in nitrogen, such as poultry manure. The majority of the leaching occurs during the first weeks of composting. As the composting process continues, the amount of nitrogen lost through leaching not only decreases, but the fraction of the leachate that is NH_4^+-N also decreases as it is gradually converted to NO_3^- .

The formation of nitrate-nitrogen is an indication of a well regulated, aerobic composting process. The amount of leachate coming from the pile also tends to increase after the pile is turned, perhaps in response to the increased porosity and aeration that help increase the microbial activity. Leaching is often independent of the addition of water, particularly during the latter stages of the active composting period. Leachate may be collected and used to add moisture to the compost pile. Returning the nitrogen and carbon contained in the leachate to the pile along with the decrease in moisture that usually occurs during composting concentrates the nutrients of a compost pile.

Denitrification is the process by which nitrates are converted to nitrous oxide (N_2O) or nitrogen gas (N_2). This process is carried out under facultative anaerobic

conditions by aerobic and anaerobic bacteria. Nitrous oxide is also responsible for part of the odors generated at a composting site.

(2) C:N ratio

Micro-organisms require certain nutrients in large amounts. Examples of some of the macronutrients required are carbon (C), nitrogen (N), phosphorus (P), and potassium (K). The relative amounts of carbon and nitrogen present have the greatest effect on the composting process and so are used as the primary indicators of nutrient content. Carbon and nitrogen are also the main nutrient focus because if these nutrients are present in the proper ratio, the other nutrients also tend to be present in the acceptable amounts.

Carbon is used both as a source of energy and for growth of microbes. In aerobic decomposition, part of the carbon is released as CO_2 while the rest is combined with nitrogen for microbial growth. As a result, the carbon content of a compost pile is continuously decreasing.

Nitrogen is used for the synthesis of cellular material, amino acids, and proteins and is continuously recycled through the cellular material of the micro-organisms. Any nitrogen that is incorporated into the cells becomes available again when the micro-organism dies. Because a large part of the carbon is continuously released while the majority of the nitrogen is recycled, the C:N ratio decreases over the composting period. If, however, the system experiences large nitrogen losses, the C:N ratio can increase.

An initial C:N ratio of 20:1 to 40:1 is recommended for rapid composting. However, C:N ratios as low as 14:1 also compost well and are practical for composting animal mortalities. Higher C:N ratios work more efficiently, but require large additions of a carbon source, such as straw, that reduce the quantity of mortalities that can be composted. If carbon is present in excessive amounts relative to nitrogen so that the C:N ratio is above the optimal range, the composting process slows. In this case nitrogen availability is the limiting factor. With only limited nitrogen resources to use, micro-organisms take longer to use the excess carbon. Several life cycles of organisms are required to reduce the C:N ratio to a more suitable level.

If the C:N ratio is too low because the raw material is rich in nitrogen, the limiting nutrient will be carbon. If

enough carbon is not available to provide the energy and material for the microbes to incorporate the products of protein decomposition, unstable nitrogen as NH_3 or NH_4^+ will form. This excess nitrogen may be released as gaseous ammonia, accumulate within the pile in toxic amounts, or leach out of the pile and potentially contaminate ground or surface water.

The measured C:N ratio of a compost mix does not always accurately reflect the amount of nutrients available to the micro-organisms. Microbial systems respond only to available nutrients and those nutrients they are able to readily use. As such, it is not only important for the mix of raw materials to have a proper C:N ratio, but also that the nutrients in the mix be in readily available forms. Material containing simple sugars, such as fruit waste, decomposes rapidly while woody material bound by decay-resistant lignins is more difficult to decompose. Most nitrogen sources are not resistant to decay except for keratin (any of various sulfur-containing fibrous proteins that form the chemical basis of epidermal tissue, such as horns, hair, wool, and feathers).

(3) Oxygen

Oxygen is necessary for the survival of aerobic micro-organisms. If sufficient oxygen is not provided to sustain aerobic micro-organisms, anaerobic micro-organisms begin to dominate the compost pile, slow the composting process, and produce odors. A minimum oxygen concentration of 5 percent is required to maintain aerobic conditions.

Oxygen can be supplied to the pile using either forced or passive aeration. Regardless of the method of aeration, the amount of air that is being supplied to the compost pile does not necessarily reflect the amount of oxygen that is actually reaching the micro-organisms. The reason for this is that the micro-organisms require an aqueous environment in which to function and, as such, are located within a thin liquid film on the surface of the compost particles. In addition, the diffusion of oxygen through water is significantly slower than that through air. Therefore, although air may be entering the pile at a sufficient rate to provide the required oxygen, the oxygen may not be reaching the micro-organisms at the correct rate. This factor must be taken into account when aerating the pile and when managing the moisture content of the pile.

(4) Water

Water is another essential component for the survival of composting micro-organisms. The micro-organisms require an aqueous environment in which to move and transport nutrients. Water is also necessary to act as the medium for the chemical reactions of life.

Micro-organisms thrive in an aqueous environment, but if the material within the compost pile is saturated, oxygen is not able to penetrate the pile in sufficient amounts to maintain aerobic respiration. The ideal moisture content for composting must therefore be a compromise between achieving adequate moisture for the micro-organisms to function and adequate oxygen flow to maintain aerobic conditions. The moisture content for composting is generally recommended to be in the range of 40 to 65 percent. Below 15 percent moisture, microbial activity ceases altogether.

The moisture content of the compost pile fluctuates during the composting process as water is lost to evaporation and added by precipitation. Moisture needs to be monitored during the process to maintain sufficient moisture and porosity. The moisture content generally decreases over the composting period and, depending on the climate, additional water may be required.

The type of material used in the compost mix also influences moisture content considerations. For example, a highly porous material can have a higher moisture content than a densely packed one.

Another function of moisture is to provide a mechanism for cooling. The heat generated during the composting process heats the pile's air and compost material and evaporates the water. The majority of the heat provides the latent heat of vaporization. This diversion of part of the heat generated provides some cooling to the pile. If the compost pile becomes too dry while it is heating during the thermophilic stage, the pile may begin to overheat because of decreased evaporative cooling.

(5) pH control and adjustment

The pH levels of the raw material of the compost mix do not significantly impact the composting process because different micro-organisms thrive at different pH levels. The ideal range for microbial activity is between 6.5 and 8.0. Composting continues at extremes, such as 5 and 9, but the process slows. By the end of the composting process, the pH generally

stabilizes between 7.5 and 8.0, regardless of the beginning pH.

The pH levels vary in response to the raw material used in the original compost mix and the production of various products and intermediates over the composting period. The first several days of the active composting period are characterized by a drop in pH to levels between 4 and 5. This depression of pH can be caused by the formation of organic acids in anaerobic zones or the accumulation of organic acid intermediates resulting from an abundance of carbonaceous substrate. Acidic conditions are generally detrimental to aerobic micro-organisms, particularly bacteria, and slow the composting process. Composting will not stop, however, because a population of organisms, mostly fungi, eventually develops that can use the acidic compounds as a substrate. As these organisms consume the acidic compounds, the pH is elevated again.

In most cases the pH does not need to be adjusted because of the natural buffering capacity of the compost pile. The pH does become a concern when material high in nitrogen is to be composted. A basic pH (> 8.5) promotes the conversion of nitrogenous compounds to ammonia. This ammonia formation serves to further increase the alkalinity and not only slow the rate of composting, but also promote the loss of nitrogen through ammonia volatilization. In such cases the pH may need to be adjusted downward below 8. The addition of superphosphate has been shown to conserve nitrogen when used with dairy manure in amounts equal to 2 to 5 percent of the dry weight of manure (Rynk 1992).

The pH must be adjusted upward only if the formation of acidic conditions in the initial stages of composting causes an extended lag period. By adjusting the pH upward, the lag time for an appropriate microbial population to develop in acidic conditions is eliminated, and rapid composting begins sooner. A basic pH also helps to control odors by preventing the formation of organic acid intermediates that are responsible for most of the odorous compounds generated at the composting site. The additive generally used for this purpose is lime ($\text{Ca}(\text{OH})_2$). A drawback to using an additive to adjust the pH is that nitrogen losses and odors through ammonia volatilization increase because the pH is alkaline for a longer period.

(6) Physical characteristics

The physical characteristics of the compost mix ingredients must also be considered when developing a compost mix. Different physical characteristics affect aeration, the amount of decomposition, and the ability of a pile to maintain aerobic conditions. The three main physical characteristics of the compost mix of main concern are porosity, texture, and structure.

Porosity is a measure of the air space within the compost mix and influences the resistance to airflow through the pile. If the pores become filled with water because of a high moisture content, then the resistance to airflow increases. Less oxygen reaches the micro-organisms, and anaerobic activity begins to dominate. Porosity is improved by a more uniform mix of material that provides continuity of air spaces, proper moisture to allow adequate free air space, and larger particles to increase the pore size and reduce the resistance to airflow.

Larger particles are desirable to promote the flow of air, but they also diminish the surface area of the particles. Because the majority of the microbial activity occurs on the surface of the compost particles within a thin liquid layer, the greater the amount of surface area exposed, the greater the amount of decomposition.

Texture is the relative proportion of various particle sizes of a material and is descriptive of the amount of surface area that is available to the micro-organisms. The finer the texture, the greater the surface area exposed to microbial activity. Minimizing the particle size by such methods as selection and grinding also increases the overall surface area of the material in the pile that is exposed to microbial decomposition.

Structure refers to the ability of a particle to resist compaction and settling. It is a key factor in establishing and maintaining porosity during the composting process. Structure is important because even a mix that has all of the necessary components may not be able to sustain rapid composting. If the pile begins to settle and close off air spaces as the material decomposes, the compost process slows. Highly absorbent material tends to maintain better structure than less absorbent material.

The ideal particle size of the compost material must therefore be a compromise between maximizing porosity, maximizing surface area, and increasing structure.

637.0202 Design of compost mixtures

Natural decomposition occurs in any pile of waste material even if the C:N ratio, moisture content, and aeration are outside the recommended limits for composting. Generally, however, decomposition proceeds at a rate too slow to be readily noticeable and also generates putrid odors. Composting is a directed effort to maximize the rate of natural decomposition, reduce the production of odors, and to destroy pathogens, weed seeds, and fly larvae. The compost mix must be designed to optimize conditions within the pile in terms of nutrition, oxygen and moisture content, and pH and temperature levels so that a high rate of microbial activity is achieved.

(a) Components of compost mix

The three components to a compost mix are the primary substrate, amendment, and bulking agent. The **primary substrate** is the main waste material that requires treatment. The appropriate material to add to the compost mix can be determined based on the characteristics of the primary substrate. An **amendment** is any material that can be mixed with the primary substrate to balance the C:N ratio, modify the pH, improve stability, and achieve the proper moisture content. More than one amendment may be added to a compost mix. A **bulking agent** is a decay-resistant material whose main purpose is to provide structure and porosity to the pile. Some bulking agents undergo little to no decomposition and can be screened from the finished compost and re-used. An amendment can also be a bulking agent.

When forming a compost mix, the physical and nutritional characteristics of the different raw material are manipulated to achieve ideal conditions for microbial activity. The two main characteristics taken into account are the C:N ratio and moisture content. If one or both of these are not sufficient to maintain rapid composting, then an appropriate amendment must be chosen to balance them. More than one amendment may be required either because of the constraints on the availability of materials or the characteristics of the amendment.

If the primary substrate cannot maintain good structure, lacks porosity, and the C:N ratio and moisture content are not appropriate, an amendment is required. If the primary substrate only requires adjustment of its structure and porosity, then only a bulking agent, such as shredded rubber tires or wood chips, is necessary.

Calculations can be made to proportion a compost mix that has the correct C:N ratio and moisture content. However, in some situations proper balance of the C:N ratio and the moisture content using the available material is not possible. In this case the mix should be designed so that either the C:N ratio or the moisture content is within the recommended ranges and the other as close as possible to the ideal range. Determining which criteria, C:N ratio or moisture content, to meet depends on the type of material and the composting method.

Generally, the compost mix is proportioned to meet the recommended range for moisture content, if both the C:N ratio and moisture content cannot be balanced. The reason is that a compost mix with improper moisture content has a more detrimental effect on the composting operation. Low moisture content halts the composting process, while high moisture content creates odors. High moisture creates odors because the voids in the compost mix are filled with moisture resulting in anaerobic conditions. The C:N ratio is then balanced so that it is above the recommended range because this will only slow the process. A C:N ratio below the recommended range, on the other hand, generates odors and leads to nutrient losses through ammonia volatilization.

Calculations alone should not be depended on to develop the proper compost mix. Intangibles of the material, such as water absorbency, degradability, and structure, may alter the mix proportions (recipe) required to maximize the composting process. For example, a mix may have the correct C:N ratio and moisture content, but will fail to compost because the carbon is not readily available or the porosity is insufficient for good aeration. Calculations provide a starting point for establishing compost recipes, but experience provides the knowledge of which materials compost the best and in what proportions.

(b) Typical raw material

The characteristics of different wastes are described in appendix 2A. Specific characteristics, such as C:N ratio and N content, of various wastes are also tabulated in the appendix. Additional information is in chapters 4 and 10 of the Agricultural Waste Management Field Handbook.

The predominant raw material (PRM) used in most onfarm composting operations is manure. Other material considered raw material is any that poses a management problem in terms of handling, cost, or environmental safety. This can include crop residue, such as alfalfa seed screenings and grass straw.

Manure, as excreted, is a nitrogen-rich material with poor structure. The amount of amendment that needs to be added depends on the consistency of the manure. Manure that is collected from the barn along with the bedding does not require a great deal of additional material, if any. Separated solids often have sufficient dry solids content to be composted directly from a separator. Slurries or semisolid consistency manure can be composted if the proper method and amendments are used. Liquid manure generally is not recommended for composting because of the dry, high carbon material that must be added in amounts that are generally not economically feasible. However, liquid manure has been successfully composted using the silo method (see 637.0210(e)(3)) and the passively aerated windrow method (see 637.0210(b)). The silo method is suitable for liquid manure because it completely contains material and can provide sufficient aeration. The passive aerated windrow method can be used with liquid manure when peat is used as an amendment. Peat has an excellent water-holding capacity and is able to give structure to the manure to promote composting. Peat also has the ability to absorb odors and is resistant to changes in the pH levels of the pile.

Typically, the amendments used for the composting operation are those that are readily available at little to no cost. The least cost and often the best source of material is onfarm material. Some that may be available are crop residue, peanut shells, rice hulls, and spoiled hay or silage. The cost of raw material may also be reduced by using wastes obtained from municipalities, such as leaves, grass clippings, newspapers, and cardboard.

Another potential source of raw material for composting may be neighboring farms where a waste material is posing a management problem. These wastes could include manure, crop residue, straw, or hay. This material can often be obtained for the hauling or at a minimal cost.

A good source of raw material is horse manure. However, manure from race tracks or show barns is problematic because it often contains noncompostable material. When obtaining material from off-farm sources, consideration should be given to the distance that the material must be transported as well as the method of transportation.

Nonfarm sources of material from other than municipalities include wood industry, landscapers, grocery stores, restaurants, and food, fish, and meat processing industries. The main concern when taking these wastes is the noncompostable material, such as plastic, it may contain, required permits and regulations, and handling and storage requirements. If these factors are not taken into consideration before composting, it may prove to be a costly mistake. For example, it should be specified beforehand whose responsibility it is to remove any noncompostable debris from the waste. It may be costly for the farmer to separate the debris. As such, many farmers insist on "clean" waste before they will accept it onto the farm for composting. Another example is grass clippings. They require special consideration because they can only be stored for short periods before they become odorous. Grass clippings also tend to lose their structure quite easily upon decomposition.

Fish processing waste includes material, such as fish gurry (residue from fish cleaning), breaching crumbs, and shrimp, crab, lobster, and mussel shells. The material also can be stored only for short periods because it decomposes quickly and becomes odorous. This waste is, however, a good source of nitrogen.

A final group of raw material is fertilizer or urea. They are not wastes that need to be managed, but are needed to adjust the C:N ratio of the mix. This material provides a concentrated source of nitrogen to raise the C:N ratio without affecting the moisture. Adding fertilizer and urea may also be most cost effective if the only options for other material to provide the needed nitrogen would be more expensive. The potential problem with using this concentrated nitrogen

material is that the nitrogen may be more readily available than the carbon resulting in excess nitrogen accumulation and loss.

(c) Determination of the compost recipe

Quite often, particularly in farm situations, a compost recipe is not specifically developed using calculations. A compost mix is instead developed by adding a carbon and nitrogen source together to achieve a pile of good structure that composts well. The benefit of developing a mix using calculations is that it provides a more accurate base from which to start even if the mix calculated on paper is not the combination eventually used.

The two possible ways to design a compost mix are to:

- Determine the proportion of material necessary to develop a mix based on the C:N ratio of the material.
- Determine the C:N ratio of the mix based on the quantity of the material available and then balance the C:N ratio and moisture content accordingly.

The first approach, to determine the proportion of materials necessary to develop a mix based on the C:N ratio of the material (Brinton, et al. 1988), is easy to calculate if only two materials are being used. The equations to start with are:

$$X_C a + Y_C b = C \quad [2-8]$$

$$X_N a + Y_N b = N \quad [2-9]$$

where:

- X_C = carbon content of material X
- a = mix proportion of material X
- Y_C = carbon content of material Y
- C = carbon content of mix
- X_N = nitrogen content of material X
- Y_N = nitrogen content of material Y
- b = mix proportion of material Y
- N = nitrogen content of mix

Example 2-1 illustrates the use of equations 2-8 and 2-9 to determine the proportion of materials needed to develop a mix based on the C:N ratio.

C, N, X_C , Y_C , X_N , and Y_N are known while **a** and **b** are the unknowns. The standard procedure for solving two equations for two unknowns using either algebraic manipulation or a determinant can be used to solve for **b** or **a**.

The calculations become more complex as the number of ingredients increases. Computer spreadsheets and programs are a great time saving way to do the mathematics.

Calculation of a complex mix may be simplified conducting a mix-ratio analysis for at least the two most important C:N ingredients (the ingredients used in the greatest amounts). If the main ingredients have been mixed in the proper proportions to achieve the target C:N ratio, any material added that has a C:N ratio close to that targeted will not significantly change the C:N ratio of the mix.

If different material is being analyzed for use in a compost mix, the number of calculations can be reduced by being aware that as long as the C:N ratio of the ingredients to be removed and replaced is the same, the new ingredient can be substituted pound for pound. Therefore, different ingredients can be exchanged and added without significantly changing the C:N ratio so that one can experiment with other characteristics of the pile, such as porosity, particle size, structure, and moisture (Brinton, et al. 1988).

The other approach to designing a compost mix is to determine the C:N ratio of the mix based on the quantities of the material available and then balance the C:N ratio and moisture content accordingly. If the moisture content and C:N ratio cannot be balanced with two ingredients, it may be necessary to add others. This will increase the number of calculations necessary. While meeting the target C:N ratio and moisture content is important, other factors, such as degradability, porosity, structure, precipitation and climate, and C:N and moisture losses, need to be considered.

The C:N ratio of a compost pile generally decreases as the carbonaceous material is decomposed and lost to the environment as CO_2 , while nitrogen is being conserved. If nitrogen is lost through volatilization, leaching, or denitrification, the loss rate is slower and in smaller quantities than the carbon. The moisture content of a pile also experiences a net decrease over

Example 2-1 Determining the proportion of materials needed to develop a mix based on the C:N ratio

Determine: Mix proportions needed to attain a C:N ratio of 35:1 using a manure having 3.7% N and a C:N ratio of 15:1 and a straw having 0.7% N and a C:N ratio of 100:1

Given: X_N = nitrogen content of material X = 3.7%, or 0.037
 X_C = carbon content of material X = $0.037 \times 15 = 0.555$
 Y_N = nitrogen content of material Y = 0.7%, or 0.007
 Y_C = carbon content of material Y = $0.007 \times 100 = 0.70$
 $C = 35$
 $N = 1$

Solution: Solving Equations 2-8 and 2-9 simultaneously

$$\begin{aligned} X_C a + Y_C b &= C & [2-8] \\ X_N a + Y_N b &= N & [2-9] \end{aligned}$$

$$\begin{aligned} 0.555a + 0.70b &= 35 \\ 0.037a + 0.007b &= 1 \end{aligned}$$

Multiply both sides of equation 2-9 by -100

$$\begin{aligned} 0.555a + 0.70b &= 35 \\ -3.7a + -0.70b &= -100 \\ -3.145a &= -65 \\ a &= 20.668 \end{aligned}$$

Solve for b using equation 2-8

$$\begin{aligned} 0.555(20.668) + 0.70b &= 35 \\ 11.471 + 0.70b &= 35 \\ 0.70b &= 35 - 11.471 \\ b &= \frac{23.529}{0.70} = 33.61 \end{aligned}$$

As a check, solve for b using equation 2-9

$$\begin{aligned} 0.037(20.668) + 0.007b &= 1 \\ 0.765 + 0.007b &= 1 \\ 0.007b &= 1 - 0.765 \\ b &= \frac{0.235}{0.007} = 33.61 \end{aligned}$$

Therefore the mix proportions would be:

$$\begin{aligned} \%a &= \frac{a}{a+b} = \frac{20.668}{20.668 + 33.61} = 38.08\% \\ \%b &= 100 - 38.08 = 61.92\% \end{aligned}$$

the composting period as moisture is constantly being lost through evaporation. Moisture loss from a compost pile is generally greater than any additions through precipitation. However, extremely wet and cold periods may result in a net gain of moisture. These conditions may require that the piles be placed under roofing. Because the moisture content and C:N ratio of the compost mix will most likely decline, they should be targeted such that they are at the upper end of the acceptable range initially. Therefore, they will remain within the recommended ranges during composting.

Moisture content can be calculated as follows:

$$M_i = \frac{\text{Wet weight} - \text{Dry weight}}{\text{Wet weight}} \times 100 \quad [2-10]$$

where:

M_i = percent moisture content (wet basis)

The general equation for determining the moisture content of a compost mix of material, such as collected manure, amendment, and bulking agent, is as follows: (The equation may contain variables that are not needed in every calculation).

$$M_m = \frac{\frac{(W_w \times M_w) + (W_b \times M_b) + (W_a \times M_a)}{100} + H_2O}{W_m} \times 100 \quad [2-11]$$

where:

M_m = percent moisture of the compost mixture (wet basis)

W_w = wet weight of primary raw material (lb)

M_w = percent moisture of primary raw material (wet basis)

W_b = wet weight of bulking agent (lb)

M_b = percent moisture of bulking agent (wet basis)

W_a = wet weight of amendment (lb)

M_a = moisture content of amendment (wet basis)

H_2O = weight of water added (lb) = $G \times 8.36$ (G = gallons of water)

W_m = weight of the compost mix (lb) including wet weight of primary raw material, bulking agent, amendments, and added water

To determine the amount of amendment to add to the compost mix to lower or raise its moisture content:

$$W_{aa} = \frac{W_{mb} \times (M_{mb} - M_d)}{(M_d - M_{aa})} \quad [2-12]$$

where:

W_{aa} = wet weight of amendment to be added

W_{mb} = wet weight of mix before adding in amendment

M_{mb} = percent moisture of mix before adding amendment

M_d = desired percent moisture content of mix (wet bases)

M_{aa} = moisture content of amendment added

Equation 2-12 can be used for the addition of water by setting $M_{aa} = 100\%$.

To estimate the C:N ratio from the fixed or volatile solids content:

$$\%C = \frac{100 - \%FS}{1.8} \quad [2-13]$$

$$W_c = \frac{VS}{1.8} \quad [2-14]$$

$$C:N = \frac{\%C}{\%N} = \frac{W_c}{W_n} \quad [2-15]$$

where:

$\%C$ = percent carbon (dry basis)

$\%FS$ = percent fixed solids, ash (dry basis)

W_c = dry weight of carbon

VS = weight of volatile solids

C:N = carbon to nitrogen ratio

$\%N$ = percent total nitrogen (dry basis)

W_n = dry weight of nitrogen

The weight of carbon and nitrogen in each ingredient can be estimated using the following equations:

$$W_n = \frac{\%N \times W_{dry}}{100} \quad [2-16]$$

$$W_n = \frac{W_c}{C:N} \quad [2-17]$$

$$W_c = \frac{\%C \times W_{dry}}{100} \quad [2-18]$$

$$W_c = C:N \times W_n \quad [2-19]$$

where:

W_{dry} = dry weight of material in question

The dry weight of the material in question can be calculated using:

$$W_{\text{dry}} = W_{\text{wet}} \times \frac{100 - M_{\text{wet}}}{100} \quad [2-20]$$

where:

W_{wet} = wet weight of material in question

M_{wet} = percent moisture content of material (wet basis)

The C:N ratio and nitrogen content for the same type of compost material varies from source to source and locale to locale. As such, table values should only be used for developing rough estimates. Using local values or laboratory testing the compost materials proposed for use is highly recommended to establish more accurately the actual C:N ratio and nitrogen content.

Equation 2-21 can be adjusted to accommodate a mix that has no bulking agent or that has several amendments. Simply omit or add the necessary variables. Every material in the compost mix must be accounted for in the equation.

$$R_m = \frac{W_{\text{cw}} + W_{\text{cb}} + W_{\text{ca}}}{W_{\text{nw}} + W_{\text{nb}} + W_{\text{na}}} \quad [2-21]$$

where:

R_m = C:N ratio of compost mix

W_{cw} = weight of carbon in predominant raw material (PRM) (lb)

W_{cb} = weight of carbon in bulking agent (lb)

W_{ca} = weight of carbon in amendment (lb)

W_{nw} = weight of nitrogen in PRM (lb)

W_{nb} = weight of nitrogen in bulking agent (lb)

W_{na} = weight of nitrogen in amendment (lb)

To calculate the weight of amendment to add to achieve a desired C:N ratio:

$$W_{\text{aa}} = \frac{W_{\text{nm}} \times (R_d - R_{\text{mb}}) \times 10,000}{N_{\text{aa}} \times (100 - M_{\text{aa}}) \times (R_{\text{aa}} - R_d)} \quad [2-22]$$

$$W_{\text{aa}} = \frac{N_m W_{\text{mb}} \times (100 - M_{\text{mb}}) \times (R_d - R_{\text{mb}})}{N_{\text{aa}} \times (100 - M_{\text{aa}}) \times (R_{\text{aa}} - R_d)} \quad [2-23]$$

where:

W_{nm} = weight of nitrogen in compost mix (lb)

W_{mb} = weight of compost mix before adding amendment

R_d = desired C:N ratio

R_{mb} = C:N ratio of the compost mix before adding amendment

N_{aa} = percent nitrogen in amendment to be added (dry basis)

R_{aa} = C:N ratio of compost amendment to be added

M_{aa} = percent moisture of amendment to be added

N_m = percent nitrogen in compost mix (dry basis)

M_{mb} = percent moisture of compost mix before adding amendment (wet basis)

For a compost mix that has a C:N ratio of more than 40, a carbonless amendment, such as a fertilizer, can be added to lower the C:N ratio to within the acceptable range. In this special case, equation 2-24 can be used to estimate the dry weight of nitrogen to add to the mix:

$$W_{\text{nd}} = \frac{W_{\text{cw}} + W_{\text{cb}} + W_{\text{ca}}}{R_d} - (W_{\text{nw}} + W_{\text{nb}} + W_{\text{na}}) \quad [2-24]$$

where:

W_{nd} = Dry weight of nitrogen to add to mix

Although the addition of dry nitrogen reduces the initial C:N ratio, the benefits are short-lived. The fertilizer nitrogen is available at a faster rate than the carbon in the organic material, leading to an initial surplus of nitrogen. This surplus is either leached from the pile or lost as gaseous and odor-producing ammonia. Adding an organic amendment that is high in nitrogen to the compost mix to reduce the C:N ratio is advised.

After the amount of an amendment to add has been determined to correct the C:N ratio, the moisture content needs to be checked to determine if it is within the proper range. It may be necessary to go through several iterations of these calculations to achieve the desired mix.

637.0203 Monitoring and parameter adjustment

The compost pile must be monitored and the appropriate adjustments made throughout the composting period. This is necessary to sustain a high rate of aerobic microbial activity for complete decomposition with a minimum of odors as well as maximum destruction of pathogens, larvae, and weed seeds. Generally, the monitoring process is monitored observing temperature, odors, moisture, and oxygen and carbon dioxide.

(a) Temperature

A convenient and meaningful compost parameter to monitor is temperature. Temperature is an indicator of microbial activity. By recording temperatures daily, a normal pattern of temperature development can be established. Deviation from the normal pattern of temperature increase indicates a slowing of or unexpected change in microbial activity. The temperature should begin to rise steadily as the microbial population begins to develop. If it does not begin to rise within the first several days, adjustments must be made in the compost mix.

A lack of heating indicates that aerobic decomposition is not established. This is caused by any number of factors, such as lack of aeration, inadequate carbon or nitrogen source, low moisture, or low pH. Poor aeration is caused by inadequate porosity that, in turn, can result from the characteristics of the material or excessive moisture. Material that is dense does not have good porosity. A bulking agent must be added to improve porosity. A mix of material that is too wet also lacks good porosity because moisture fills the air spaces making oxygen penetration of the pores more difficult. The addition of a dry amendment with good absorbency helps to decrease the moisture content of the pile and improves porosity.

The pile may also fail to heat because of excessive heat losses. This is caused either because the pile is too small or exposure to cold weather is promoting heat loss. A pile that is experiencing excessive heat loss because of its size requires a larger volume-to-

surface area ratio to retain heat. The surface area exposed to the atmosphere is reduced while at the same time the volume that is insulated by the pile increases.

Another possible reason for the failure of a compost pile to heat is that the initial mix is sterile or does not have a large microbial population. If the initial microbial population is small, it will take longer to develop and grow. This is generally not a problem with waste material, such as manure or sludge, but can be a problem with "clean" material, such as newspaper or potato waste. The addition of some active composting material, such as manure or finished compost, can be used as sources of inoculant.

When fresh chicken litter is available, "hot litter" can be used as an effective inoculant. Hot litter refers to chicken litter that is managed to maintain a high population of micro-organisms. Litter fresh from a poultry house typically is high in micro-organisms. However, the number of micro-organism declines rapidly if adequate water and air are not provided. A convenient way to keep fresh litter "hot" is to maintain a supply of chicken litter in a pile that is kept moist and is turned on a daily basis. As part of the hot litter is removed to operate the compost piles, an equal volume of older litter is added to the hot pile, water is added, and the pile turned for mixing and aerating. This method allows all the required water to be added to the hot litter pile, and maintains a micro-organism-rich litter supply with an initial temperature of 120 degrees Fahrenheit.

A pile that begins to cool after achieving thermophilic temperatures is nearing the end of the composting process or has become unable to maintain aerobic conditions. A lack of moisture or aeration is generally the cause in the latter circumstances. A loss of aeration can occur during composting as a result of a loss of structure and porosity as the material decomposes and the pile begins to collapse. Aerobic conditions can be reestablished by turning or mixing the pile to rebuild porosity.

Uneven temperatures within a pile indicate a nonuniform mix of material and subsequently leads to uneven decomposition. Cold spots in the mix indicate sites of anaerobic decomposition that have the potential to produce odors and phytotoxic compounds. This is generally a problem with static piles that are not

turned during the composting period. Composting in static piles may also be uneven because of compaction. As the material in the pile begins to decompose, the pile settles and begins to close off air spaces at its base. Therefore, the base of the pile undergoes decomposition to a lesser degree than the upper part.

Thermophilic temperatures indicate that intense microbial activity is taking place. Exceedingly high pile temperatures ($>170^{\circ}\text{F}$), however, are not so much an indicator of vigorous microbial activity as a sign that the pile is unable to control its temperature. A pile begins to overheat if it traps too much of the heat being produced. Generally, the pile is too large or too dry to allow for enough cooling through evaporation. A greater amount of surface area needs to be exposed to allow for sufficient release of heat to the atmosphere, and adequate moisture needs to be maintained.

A typical composting pile does not heat uniformly throughout, but has a temperature gradient from the hot inner core to the cooler surface temperature. To properly assess the pile temperatures, measure the hottest temperature that is in the pile. Generally, the hottest temperature initially occurs at 12 to 18 inches inside the compost pile and then penetrates deeper into the pile with time. If the pile is not heating at the 12- to 18-inch depth, it is a good indication that the entire pile is not heating. Temperature variations along the length of pile are also not uncommon because of an uneven mix, varying degrees of microbial activity, and other varying conditions throughout the pile. Readings at 50-foot longitudinal intervals are recommended.

(b) Odor management

Next to temperature, odor is the most effective and simple indicator of whether the pile conditions are aerobic and, also, to a certain degree, if nutrient losses are occurring through ammonia volatilization. Odor management is an important aspect of the composting operation, particularly if the operation is in close proximity to neighbors.

Odors may be detected before composting starts. These odors are generally caused by the raw material itself. This is particularly true for material, such as fish processing waste and manure. However, these odors

generally disappear. After the material is incorporated into the compost pile, the odors are masked by the other material in the pile or eliminated because the microbes in the compost mixture use the odorous compounds as substrates.

Strong, putrid odors that sometimes smell of sulfur, indicate anaerobic activity, particularly when these odors are accompanied by low temperatures. Anaerobic conditions generally develop in response to high moisture, low porosity environments. If excess moisture is not the cause, then the pile may be too large, leading to compaction and inadequate aeration, or the porosity of the material is insufficient. If ammonia odors are produced by the compost pile, then it may need to be managed for nitrogen conservation, particularly if nutrient losses are a concern. Such management techniques include reducing the turning frequency and adding carbon-rich material to the mix.

Odor detection is subjective and therefore difficult to quantify or measure. Regardless, the best method of odor detection is the human nose. Once odors have formed and are detected, they are difficult to remove. The most effective approach is to manage pile conditions to minimize odor generation. If odors have developed, the best solution is to modify conditions within the pile so that odor production is not continued. Odor-masking chemicals are available; however, their use is restricted mostly to treating the air of indoor composting operations.

(c) Moisture

The maintenance of proper moisture can be a problem for a composting operation. The moisture conditions in the pile vary constantly throughout the composting period mainly because of the large amounts of evaporation and the addition of water through precipitation. Improper moisture can slow or stop the composting process, lead to anaerobic conditions, and produce odors. A dry pile is not only detrimental to microbial activity, but forms dust that carries odors and possible fungal pathogens, such as *Aspergillus fumigatus*. Maintaining the moisture level between 40 and 60 percent alleviates these potential problems.

Problems associated with maintaining proper compost moisture levels are related to the climate. In hot, arid climates moisture is difficult to maintain because of

excessive losses caused by evaporation. If the pile becomes too dry, the composting process can be halted prematurely. This becomes a problem particularly if the compost is to be sold in bagged form because once the compost is rewetted, the composting process begins again. Once composting begins, it quickly becomes anaerobic because of the lack of an oxygen supply. This eventually produces odors and phytotoxic compounds. In wet or humid climates, excess moisture is a problem. In these operations the piles may require additional turnings to release moisture, the addition of a larger quantity of dry amendments, or roofing.

The simplest methods for correcting a low moisture problem in a pile are to turn it after a rainfall or to spray water onto the pile during turning. A hose can be inserted under the insulating layer of a static pile so that water penetrates. Water should be added gradually to minimize moisture losses through runoff and to prevent the addition of too much water. The water used to wet the pile can be runoff from the composting area that is collected in a pond or lagoon, irrigation water, or liquid manure.

A simple, low technology method of checking the moisture content is called the squeeze test. If the compost is damp to the touch, but not so wet that water can be squeezed out of a handful of the compost, the compost has sufficient moisture to sustain composting. A more precise measure can be obtained by weighing a sample before and after drying it in an oven or microwave or under hot air.

(d) Oxygen and carbon dioxide

Oxygen levels within the pile can also be used as an indicator of how the composting process is developing. As aerobic activity increases, the oxygen consumption should also increase causing the oxygen levels to decrease. Measuring oxygen levels to monitor the composting process is not as accurate as measuring temperatures. Oxygen monitoring is most useful to show that stability has been reached. Oxygen levels remain low during the active composting period. However, as the pile reaches maturity and microbial activity begins to slow, oxygen levels rise.

Because CO₂ (carbon dioxide) is a product of aerobic respiration, it can also be used as an indicator of microbial activity. The CO₂ levels should increase as microbial activity develops and decrease as the composting process approaches maturity.

(e) Monitoring equipment

The types of monitoring equipment used depend on the degree of management the operator wishes to provide. All operations require a thermometer to establish normal temperature profiles, turning schedules, or microbial activity. Sophistication of the equipment varies. The simplest, least expensive is a dial thermometer with a 3-foot-long pointed probe. The main drawback to this thermometer is that it takes time for the readings to stabilize. This becomes time consuming when temperature monitoring requires that a number of readings be taken. For these situations it might be worth the additional expense to purchase a fast-response thermometer. Other features that vary between thermometers are whether the readout is analog or digital and the length of the probe that can range from 3 feet to 6 feet. Thermometers generally range in price from the least expensive dial (analog) thermometers and mid-priced digital, fast-response thermometers, to the most expensive computerized thermocouple thermometers.

A pH meter ranges in price depending on features, such as accuracy, temperature compensation, automatic calibration, and range.

CO₂ and O₂ testers are available with sensors, an aspirator, and a sniffer probe. Samples should be taken from the part of the pile where microbial activity is expected to be the most vigorous and O₂ levels expected to be the lowest (inner core of the pile). The potential drawback to monitoring oxygen levels is that low O₂ readings may not result from vigorous microbial activity, but a lack of oxygen penetration into the pile. Carbon dioxide levels should be just the opposite of oxygen levels because carbon dioxide is a product of aerobic respiration.

637.0204 Odor generation

Odor generation is one of the primary concerns of any composting facility. It is important to know the different ways in which odors can be formed so that ecological conditions can be manipulated for their prevention and treatment.

Odors produced at the beginning of the composting period are generally caused by the nature of the material used. Material, such as manure or fish processing wastes, often have a strong odor in the initial stages of composting that diminishes as composting proceeds. Odors generated during the composting period result from the production and release of odorous compounds through either biological (microbial respiration) or nonbiological means (chemical reactions). Odors can be in gaseous form or associated with particulates, such as dust.

The main compounds responsible for odor generation are sulfur compounds, nitrogen compounds, and volatile fatty acids.

Sulfur compounds are produced by various processes. They are produced biologically through the decomposition of sulfur containing compounds (cystine, methionine) or through the assimilation of sulfur compounds. Aerobic respiration produces significantly less volatile organics than anaerobic respiration. Volatile sulfur compounds are also produced nonbiologically through the reaction of various compounds that accumulate within the pile.

Volatile fatty acids are also responsible for odor generation. They are intermediates in carbohydrate metabolism and accumulate in anaerobic systems.

Although the generation of odors generally is associated with anaerobic composting, aerobic decomposition also generates odors, particularly through the volatilization of ammonia. Decomposition of proteins leads to the formation of ammonia or ammonium by the process of ammonification. NH_4^+ and NH_3 then readily interconvert based on the pH of the environment. NH_4^+ is the preferred form in acidic conditions while NH_3 exists in basic conditions. The vapor pressure of NH_3 is low and readily volatilizes at low temperatures.

Ecological factors influence the amount and type of odorous compounds produced and whether they are released. The initial chemical composition of the compost mix, oxygen concentration, oxygen diffusion rates, particle size, moisture content, and temperature influences odor production. High temperatures facilitate the release of odors because of increased vapor pressure, increased rate of nonbiological reactions that produce odor generating compounds, and decreased aerobic decomposition.

The production of odorous compounds within a compost pile does not necessarily mean that odors will be released. These compounds can move to other parts of the composting pile where they are decomposed to nonodorous compounds. For example, hydrogen sulfide that is produced through anaerobic decomposition can be converted to sulfur rather quickly in aerobic zones. If this does not occur, then the compounds are released into the atmosphere and odor results.

Biofilters are a proven effective treatment method for removing odor during composting. They use microorganisms to decompose odorous organic compounds. Because the majority of odor-generating compounds released during composting are metabolic intermediates that can be further metabolized into innocuous products, they are readily utilized by the microorganisms.

Peat effectively adsorbs ammonia, which reduces ammonia losses. It works best when used to filter the exhaust air coming from the pile instead of mixing it directly into the compost.

Soil filters also control odors, particularly those caused by gaseous products, such as ammonia and volatile organic acids. Soil is an effective medium for removing odors through chemical absorption, oxidation, filtration, and aerobic biodegradation of organic gases. Soil filters require a moderately fine textured soil, sufficient moisture, and the ability to maintain pH within a range of 7.0 to 8.5.

637.0205 Additives, inoculums, starters

A lag time of several days occurs at the start of the composting period before the compost pile temperatures reach thermophilic levels. This lag time is required for the microbial population to grow and develop. Compost additives are available that either reduce or eliminate this lag period and improve the compost process.

Starters, also referred to as inoculums, consist of microbes and enzymes. They are added to the initial compost mix and generally make up about 10 percent of the mix. Additives are substances added to the initial mix to adjust the C:N ratio or pH or to control odors.

In theory, the addition of inoculums to the compost should work for several reasons. Theoretically, the introduction of a mass of enzymes and micro-organisms to the initial compost mix eliminates the need for a microbial population to grow and develop. As such, vigorous microbial activity and decomposition should begin almost immediately. The introduction of certain micro-organisms and enzymes to the pile may also improve the decomposition throughout the composting process. This encourages a more efficient and thorough degradation of the compost material, which, in turn, improves the quality of the final product. However, the differences between theory and reality are significant mainly because of the complex processes and microbial populations that exist within any given compost pile.

None of the beneficial effects of adding a microbial starter are possible unless the inoculant is representative of the microbial population that optimizes the composting process. Inoculums are also only useful if they supply micro-organisms not already present in the waste, add to a population that is lacking, or are more effective than those micro-organisms already in the compost mix (Golueke 1991). The reality is that these requirements are extremely difficult to determine, particularly given the extremely diverse and constantly changing environmental and microbial aspects of a compost pile. Because the internal environment is constantly changing, the inoculum also

may not necessarily be as effective as expected. Another reality is that micro-organisms that are introduced into the pile are not adapted to prevailing conditions within the waste as are the indigenous microbial populations. The microbial populations that develop during the composting process do so in response to the breakdown of various substrates and environmental conditions. Pile conditions may not be immediately suited to the microbial population that is being inoculated, resulting in a less than optimal performance.

Enzymes are another important component of inoculums and starters because they ultimately break down the organic matter in the compost mix. Appropriate enzymes are even more difficult to pinpoint because of their specificity and their sensitivity to environmental conditions, particularly temperature fluctuations. Enzymes denature at elevated temperatures. The use of enzymes in inoculums is also costly. This cost is not easily justified by any significant differences seen in the composting process when they are used.

Additives can also be material added to the initial compost mix to adjust the C:N ratio or pH of the initial mix, or to attempt to control odors. Additives used to adjust the C:N ratio include fertilizers, urea, or other concentrated sources of nitrogen. These additives lower the C:N ratio without altering the moisture content of the mix and often provide the required amount of nitrogen at a lower cost than some other source. The drawback to using a concentrated source of nitrogen to lower the C:N ratio is that the nitrogen is available at a faster rate than the organic carbon. This may result in an accumulation of nitrogen that is lost as gaseous ammonia or leached from the pile.

Many claims are made by the suppliers of various starters. To evaluate the validity of these claims requires substantial knowledge of microbiology and enzymology. Therefore, the best determinant is to test the starter in field conditions by inoculating one pile and using another pile as a control. The results of the composition of each pile are then compared to see if the starter performed as claimed.

The debate about whether inoculums or enzymes really do improve the composting process is ongoing. An additional argument is that if they make a difference, is this difference significant enough to make their use economically practical. This is especially of

concern because material can be successfully composted without adding inoculums and because inoculums and enzymes are fairly expensive to purchase. Whether the improvements that a particular inoculum may have on a process are from the microbial population that is introduced or from the additional nitrogen that is put into some inoculums must be determined. For this, an additive, such as fertilizer that supplies additional nitrogen, can be used. Continued research in this area is necessary to determine the effects of inoculums and enzymes on the composting process. Topsoil or finished compost can be added to the pile to supply microbes.

637.0206 Pathogens

One of the aspects of composting that makes it an attractive alternative to the direct application of untreated manure is the high degree of pathogen destruction that is possible with a well-managed composting operation. The pathogen content of the compost is important because improperly treated compost can be a source of pathogens to the environment and, as such, a threat to humans and animals. This depends on the type of pathogen involved. The type and quantity of pathogens in the initial compost mix are dependent on the waste that is being composted. Animal pathogens are in manure and on plant residue that has come into contact with any manure. Plant pathogens are in plant residue.

Pathogenic micro-organisms that may be in compost include bacteria, viruses, fungi, and parasites. Although parasites and viruses cannot reproduce apart from their host, they can often survive for extended periods. If they are not killed during the composting process, they can survive until the compost is land applied. At that time they may infect a new host.

Bacteria and fungi, by contrast, do not require a host to reproduce. Even if their numbers are reduced in the composting process, their population may recover and increase if conditions permit and given enough time. Therefore, it is not enough to reduce their numbers. Pathogenic bacteria and fungi must be killed in the mature compost. Conditions unfavorable to pathogenic growth include a lack of assimilable organic matter and a pile with moisture content of less than 30 percent. Because such conditions are difficult to achieve in mature compost, as many pathogens as possible should be destroyed during the composting process.

Pathogens can be destroyed by heat, competition, destruction of nutrients, antibiosis, and time (Hoitink, et al. 1991). Antibiosis is the process by which a micro-organism releases a substance that, in low concentrations, either interferes with the growth of another microbe or kills it.

Most pathogens do not grow at the optimum temperatures for composting. As such, exposure to high (thermophilic) temperature kills them. The few exceptions

to this are among fungal plant pathogens. Some of these pathogens can withstand temperatures over 180 degrees Fahrenheit. Most pathogens originating from animals cannot survive above the 130 to 160 degrees Fahrenheit temperature range.

Pathogens can also be destroyed as a result of competition with the indigenous microbial population for nutrients and space. Pathogens are at a disadvantage because they are not as well adapted to the environment as the indigenous population and their numbers are insignificant relative to the indigenous population. Pathogens must compete with the indigenous microorganisms for sites of attachment on the waste particles. However, because of the sheer number of indigenous microbes with which they must compete, the pathogens will be displaced.

The destruction of readily available nutrients also contributes to the destruction of pathogens. Nutrient requirements of pathogenic microorganisms are specific. If their key nutrients are used by the competing indigenous microbial population, then the pathogens are deprived of nutrients, and they will die.

None of the mechanisms of pathogen destruction described here result in high pathogen kill unless sufficient time is allowed for them to take full effect. Most of these mechanisms are difficult to monitor and quantify; therefore, temperature and time are the main indicators used to verify optimal pathogen destruction.

Good pathogen destruction is possible with the various composting methods if the windrows or piles are managed correctly. The two essential elements in achieving good pathogen destruction are:

- All of the material must be exposed to lethal conditions either simultaneously or successively.
- The exposure must last for a sufficient amount of time to maximize its effectiveness.

In the windrow system, pathogens theoretically are killed through the process of turning. During turning the innermost layers that have the highest temperature levels and greatest degree of pathogen destruction are exchanged. The outermost layers that have not been exposed to these lethal conditions are then allowed to reheat so that all material within the pile is exposed to the lethal temperature conditions. In reality, however, the outermost and innermost layers are not simply exchanged, but are instead thoroughly mixed so that the innermost layer is recontaminated with pathogens from the outermost layer. To counteract the effects of recontamination and ensure complete pathogen destruction, either the frequency of turning or the duration of the active composting must be increased. In-vessel systems also experience the same problems with recontamination because they rely on mechanical agitation to mix the compost.

Aerated static piles should, in theory, allow for better pathogen destruction than turned windrows and those methods in which material is turned because static piles do not have the same potential for recontamination. The top layer of insulating material should also help to maintain even temperatures throughout the piles so that pathogen destruction is increased. In reality, however, the ideal mix of material generally cannot be achieved. The less than ideal mix results in short-circuiting air through the pile leaving cool patches of undegraded compost. These cool patches contain pathogenic organisms that can survive the composting process and contaminate the finished compost.

637.0207—Health risks of a composting operation

(a) Bioaerosols

A health concern in the operation of composting facilities is the presence of bioaerosols. Bioaerosols are organisms or biological agents that are transported through the air and, under certain specific conditions might cause health problems when inhaled in sufficient quantities (Biocycle, Jan 1994, p. 51). Bioaerosols include bacteria, fungi, actinomycetes, arthropods, endotoxins, microbial enzymes, glucans, and mycotoxins. They can act as toxicants, pathogens, and allergens. The mere presence of bioaerosols at a composting site does not mean that they necessarily pose a health risk. They must also be present in a dosage sufficient to cause an infection. Most people are not affected by bioaerosols. In many cases bioaerosols only affect individuals who are predisposed to infection. Lowered immunity because of disease and some medications can render an individual vulnerable to infection.

The bioaerosols of main concern at composting facilities and most commonly mentioned in the literature are *Aspergillus fumigatus* and endotoxins. *Aspergillus fumigatus* is a secondary pathogen that infects individuals who are predisposed to infection because of lowered resistance because of diseases or disorders that affect the immune system or lungs. Diseases of susceptible individuals include AIDS, leukemia, lymphoma, and asthma. Medication, such as antibiotics or steroids, that interferes with the normal flora within the respiratory tract that prevent infection and inflammation can also lower resistance. If *Aspergillus fumigatus* infects an individual, that person can develop allergic bronchopulmonary aspergillosis. If it is not detected and properly treated, aspergillosis cannot only become a chronic and debilitating pulmonary disease, but can also affect other tissues. For example, if exposure has occurred because of a punctured eardrum, the ear can become infected.

Aspergillus fumigatus is in various kinds of decaying organic matter and in a variety of locations, ranging from households and hospitals to forests and composting sites. This opportunistic fungus is heat tolerant and

is not destroyed by the thermophilic temperatures of composting. It is also airborne and can be inhaled by humans.

Another health concern of composting facilities is the presence of endotoxins. Endotoxins are metabolic products of gram-negative bacteria that are part of the cell wall and will remain in the bacteria after it has died. Endotoxins are not known to be toxic through airborne transmission, but can cause such symptoms as nausea, headache, and diarrhea.

The dispersion of bioaerosols is related primarily to the amount of dust that is released and the material being processed. Bioaerosols are in the highest concentrations during such dust producing activities as shredding and screening and during the mixing of vegetative material, such as wood chips and brush. Maintenance of the moisture content above 40 percent, particularly during shredding, screening, turning, and mixing, helps to reduce dust formation. The bioaerosols released during composting, particularly *Aspergillus fumigatus* spores, generally are confined to the composting area and have only minimal impact beyond 300 feet from the composting site.

Bioaerosols are a more prominent problem with municipal solid waste composting facilities than agricultural waste composting facilities. This is because of the differences in the nature of the material being composted and the amount of dust that is generated at each. Screening and shredding produce the greatest amount of dust and generally are not part of agricultural waste composting operations. Bioaerosols are not a major concern to the health of workers unless an individual is taking immuno suppressant medication, is an insulin-dependent diabetic, or has severe allergies. A simple, yet effective safety precaution is to wear a respirator that can filter out particles as small as 1 micron.

A properly selected and worn respirator can provide protection from dust and mold spores. Common nuisance dust masks do not provide significant protection. They generally have only one elastic attachment strap and do not seal well around the face. The respirator used should be approved by the National Institute for Occupational Safety and Health (NIOSH) or the Mine Safety and Health Administration (MSHA). If the respirator or filter has a number preceded by the prefix TC, it is approved.

The two categories of respirators are air-purifying and supplied-air. Air-purifying respirators are equipped with filters through which the wearer breathes. These respirators do not supply oxygen and should not be worn in areas considered immediately dangerous to life or health (IDLH). These areas include oxygen-limiting silos and highly toxic atmospheres, such as those in tanks that contain or have contained manure and in compost leachate collection systems. Air-purifying respirators provide protection when turning dusty piles of compost, bagging compost, or handling dusty hay. These respirators include mechanical filter respirators (reusable or disposable) that trap particles during inhalation and powered air-purifying respirators that use a motorized blower to force air through the filtering device.

Supplied-air respirators are the only kind of respirator that may be used in leachate collection systems, tanks, and sumps that are considered IDLH. These respirators supply the wearer with fresh, clean air from an outside source. The two types of supplied-air respirators are air line respirators and a self-contained breathing apparatus (SCBA). Air line respirators provide clean air through a hose that is connected to a stationary air pump or tank. A self-contained breathing apparatus (SCBA) has a portable air tank that is carried on the back like those worn by scuba divers and firefighters. Training is required to use a SCBA effectively. This training should be provided by a safety professional, industrial hygienist, or product representative of the SCBA manufacturer.

637.0208 Aeration requirements

The correct amount of aeration for aerated static piles can be determined using basic guidelines as refined through trial and error. The correct amount of aeration must be determined to provide for the desired amount of moisture removal and temperature control while maintaining aerobic degradation. Aeration rates are established for sludge composting, but are not well established for agricultural operations because most agricultural operations do not use forced aeration. Therefore, rates are often based on those used for sludge composting. In this section general calculations are given to help estimate the aeration rates required. These calculations are taken from those suggested by Haug (1986). Various factors affect these estimates.

The supply of air to the compost pile satisfies three requirements (Haug 1986):

- Oxygen demands of aerobic decomposition
- Removal of moisture to facilitate drying
- Removal of heat produced during decomposition to control process temperatures and to prevent microbial inactivation

The first requirement of forced aeration is to meet the stoichiometric oxygen demand. The compost pile must have sufficient oxygen to carry out the microbial decomposition of the organic matter. This is a difficult parameter to determine because of the heterogeneous nature of agricultural composting mixes. In addition, the amount of oxygen supplied does not necessarily reflect the amount of oxygen that is reaching the micro-organisms because of the differential diffusion of oxygen in water and in air. Because stoichiometric oxygen demand is significantly less than that for moisture and heat removal, if the aeration demands for moisture and heat removal are being met, then the stoichiometric oxygen demand is also being met.

The aeration rate required for moisture removal can be estimated by taking into account certain environmental factors and the amount of moisture that needs to be removed from the initial mix of materials to achieve the final moisture content. This must consider that the amount of moisture in saturated air increases with increasing air temperature. As such, a large amount of

moisture is removed once thermophilic temperatures are reached. Even piles in climates with high ambient humidity experience significant amounts of drying. This is because the relative humidity of the inlet air has only a minor effect on moisture removal if the difference in temperature between the inlet and outlet air is greater than 45 degrees Fahrenheit (25 °C) (Haug 1986).

The amount of air needed for moisture removal can be estimated using the temperature of the inlet air and exit air and either standard psychrometric charts and steam tables, or by using the following equations. To calculate the saturation water vapor pressure of the inlet and outlet air:

$$\log_{10} PVS = \left(\frac{a}{T_a} \right) + b \quad [2-25]$$

where:

PVS = saturation water vapor pressure, mm Hg

a = constant, -2238 for water vapor

b = constant, 8.896 for water vapor

T_a = absolute temperature (K)

inlet T = ambient T

outlet T = pile T

From equation 2-25, the actual water vapor pressure can be estimated:

$$PV = (RH)PVS \quad [2-26]$$

where:

PV = water vapor pressure, mm Hg

RH = relative humidity, ratio of actual water vapor pressure to saturation vapor pressure

PVS = saturation water vapor pressure, mm Hg

The air that exits the composting pile is near saturation and about the same temperature as the composting material. Therefore, the relative humidity within the composting pile is taken to be 100 percent. Using the results of equation 2-26, the specific humidity of the inlet and outlet air can be calculated:

$$\begin{aligned} w &= 0.622 \left(\frac{PV}{P_a} \right) \\ &= 0.622 \left(\frac{PV}{(P_t - PV)} \right) \end{aligned} \quad [2-27]$$

where:

w = specific humidity, ratio of the mass of water vapor to the mass of dry air in a given volume of gas mixture (lb water/lb dry air)

PV = water vapor pressure, mm Hg

P_a = atmospheric pressure of dry air, mm Hg

P_t = total atmospheric pressure, mm Hg

The net removal of water vapor is the difference between the specific humidity of the inlet air minus the specific humidity of the outlet air.

The quantity of air needed to remove the required amount of water (lb dry air/lb compost mix) can then be calculated by:

$$= \frac{\text{lb water to remove}}{w_o - w_i} \quad [2-28]$$

where:

w_i = specific humidity of inlet air, lb water/lb dry air

w_o = specific humidity of outlet air, lb water/lb dry air

Air is required for heat removal because excessive temperature destroys the beneficial micro-organisms responsible for composting. Heat is required for vaporization and to heat the moisture and the dry air to the exit temperature. The heat comes from the energy liberated by the decomposition process that, in turn, depends on the amount of oxygen supplied. The heat lost to the surroundings is considered negligible. If the heat generated is greater than that lost to vaporization and heating of the air and water, then the temperature of the pile rises. This is desirable up to a point because biochemical reaction rates increase exponentially with temperature. When the temperatures become too high, however, they inactivate the microbial populations.

The required air supply generally is determined by the amount of air needed to control heat removal, particularly if moisture removal is not a primary concern of the composting operation. The amount of heat that needs to be removed is difficult to pinpoint because of the number of variables involved. A starting point can be estimated that can be fine tuned through trial and error.

Heat generation is difficult to estimate for several reasons. One reason is that complete decomposition of the original mix does not occur nor will it all be aerobic. A second reason is that the rate of oxidation varies. A third reason is that the heterogeneous nature of the compost mix is difficult to define in terms of composition.

To determine the amount of heat that will be released, the oxygen requirements for decomposition must be estimated. This requires knowledge of the primary chemical formula of the composting material.

Organics:

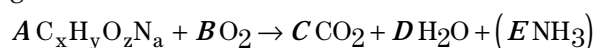

Balance and determine: lb O₂/lb organic compound

Amendment:

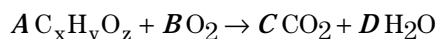

Balance and determine: lb O₂/lb amendment

Nitrification:

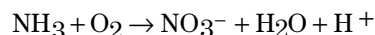

The oxygen required for nitrification is generally neglected because the oxygen demand for nitrification is significantly less than that for organic oxidation. Also, most of the ammonia is not oxidized, but lost through either volatilization or synthesis into microbial cells.

The total oxygen demand (lb O₂/lb compost material) can then be estimated by multiplying the quantity of organics and amendment to be composted by the value obtained above for pound air per pound material.

The value as given by Haug (1986) to calculate the amount of heat released per pound of compost is 5,866 Btu/lb O₂. Therefore:

$$x(h_v + h_m + h_a) = 5,866 \times \text{lb O}_2 / \text{lb compost material} \quad [2-29]$$

where:

- x = lb air/lb compost
- h_v = heat of vaporization
- h_m = heat required to heat moisture to exit temperature
- h_a = heat required to heat air to exit temperature

$$h_v = x \times (w_o - w_i) \times h_v \quad [2-30]$$

where:

- h_v = heat of vaporization at exit (pile) T, Btu/lb
- w_i = specific humidity of inlet air, lb water/lb dry air
- w_o = specific humidity of outlet air, lb water/lb dry air

$$h_m = x \times (w_o - w_i) + w_i \times h_s \times (T_o - T_i) \quad [2-31]$$

where:

- h_m = heat required to heat moisture to exit T
- x = pounds dry air required to maintain compost temperature at some T_o
- w_i = specific humidity of inlet air, lb water/lb dry air
- w_o = specific humidity of outlet air, lb water/lb dry air
- h_{wv} = specific heat of water vapor, Btu/lb-°F
- T_o = exit T, °F
- T_i = inlet T, °F

$$h_a = x \times h_{air} \times (T_o - T_i) \quad [2-32]$$

where:

- x = pounds dry air required to maintain compost temperature at some T_o
- h_{air} = specific heat of air, Btu/lb-°F
- T_o = exit T, °F
- T_i = inlet T, °F

To determine the air supply needed, the quantity of air required must be converted into a rate. The average rate of aeration can be estimated as:

$$(x) \times \frac{2,000}{(d) \times (0.0748)} \times 24 = \frac{\text{standard cubic feet per hour}}{\text{dry ton per day}} \quad [2-33]$$

where:

- x = pound dry air required to maintain compost temperature at some T_o
- d = duration of composting period, days
- 0.0748 = density of air at standard condition (20 °C, 760 mm Hg)

Because the oxidation rate varies throughout the composting period, this number is an estimate of the average rate of aeration and does not reflect the peak rate of aeration. Peak aeration rates are necessary at

certain times. Estimates of peak aeration rates for sludge composting as previously established are in the range of 4,000 to 5,000 standard cubic feet hour per dry ton.

Haug's article in the October 1986 edition of *Biocycle*, *Composting Process Design Criteria* (pp. 53–57), gives a design example and further description of aeration requirements.

637.0209—Analysis of raw materials and compost

Depending on the needs of the operation and the end-use of the compost, laboratory analysis of the raw material and finished compost may be prudent. Laboratory analysis of the raw material is important for operations that are in the beginning stages of setting up a compost operation and are attempting to establish a compost mix. Because the characteristics of the raw material vary between and within batches, literature values may not be appropriate. Laboratory analysis allows the operator to formulate a more ideal mix. Laboratory analysis of the raw material may also be prudent to determine if it contains contaminants that may not degrade during the composting period. For example, heavy metals are in some cardboard that may be used in composting. Also, pesticides may be attached to some crop residue that may be used in composting.

Analysis of the finished compost may be required to determine nutrient content if the compost is to be sold on the basis of its fertilizer content. Knowing the nutrient content of the finished compost that will be land applied helps determine proper application rates. Simple analyses can be performed on the farm using onsite testing equipment. More sophisticated analyses requiring specialized equipment and methods need to be performed by independent or agricultural laboratories.

A sample of either the raw material or compost for laboratory analysis must be representative of the pile. To ensure that the sample describes the general qualities of the entire lot, several samples should be taken from different areas of the pile and then combined. A sample from this combined mix can then be taken for analysis. Samples taken from a compost pile should not be taken from the edges, outer surfaces, or center. These are all regions of either very low or very high microbial activity and are not representative of the entire pile. A compost pile that has been stored outside and exposed to precipitation may also have different moisture and soluble salt concentrations at the edges and center of the pile. This is caused by water puddles that form at the base of the piles and the leaching of salts that concentrate at the center of the pile.

A sample should be tested as soon as possible after it is taken to reduce the risk of any changes in the characteristics that may occur as a result of exposure to conditions different from the pile. It is best to store the material covered in the refrigerator if testing cannot be performed immediately.

The sample size should be convenient to work with and be suitable for the containers and equipment being used. It should also be large enough to provide a representative sample yet not so large that it makes the tests too time-consuming or difficult. The sample size can range from a fraction of a pound to several pounds depending on what the laboratory or individual doing the testing requires. Once a particular size has been chosen, it is best to use the same sample for any replicates. If samples are being tested by a laboratory, the laboratory should be consulted as to what size sample is required.

Frequent analysis of material through independent laboratories can become expensive; however, simple tests can be performed on the farm using onsite testing equipment. They include tests for moisture content, density, pH, soluble salts, and particle size distribution. These tests are outlined in appendix 2B.

(a) Determining moisture content

The moisture content of a sample can be determined quite easily either on the farm using available or field-test equipment or in a laboratory. Moisture content can be expressed on a wet basis, dry basis, or as the fixed solids content. The moisture content as expressed on a wet basis gives the percentage of the original wet sample that is water. This is useful for determining whether a compost mix has the correct moisture for composting or if the finished compost is sufficiently dry.

Moisture content expressed on a dry basis denotes the moisture content as a percentage of the sample after it has been dried. The content remaining after a sample has been dried are known as the total solids. Because a dry sample is defined as the total solids of a sample, the dry basis moisture can also be expressed as units of moisture per unit of total solids. Dry basis moisture is useful when calculating moisture changes. This is because the total solids base remains constant even as the material dries and results in a more accurate

description of the moisture changes that are occurring in the sample. The microbiological activity of composting can, however, alter the total solids content over the course of the composting period as organic matter is consumed and decomposed. In this case the moisture content expressed on a fixed solids basis is helpful. Fixed solids are composed of inorganic matter and are biologically inert. This part of the sample is not consumed or degraded by the microbiological activity of composting. Moisture content on a fixed solids base can therefore be useful in describing the moisture changes that occur in compost over the composting period.

The first step in measuring the moisture content of a given sample is to determine the weight of the sample. The container that holds the sample should be weighed empty first and then weighed again with the wet sample. This sample is then dried in stages until it no longer loses water weight. To ensure that the weight being lost is because of water losses and not organic matter losses through volatilization, drying must be carried out at low temperatures over extended periods. For this test, the sample should not be too large because the larger the sample, the longer it takes for the sample to dry. Sample sizes generally range from 10 to 100 grams. Depending on the size and moisture content of the sample, drying requires 24 to 72 hours at 140 to 220 degrees Fahrenheit. If a 600-watt microwave oven is being used, 6-minute intervals at maximum power is recommended (Rynk 1992). If burning occurs during drying, the results are not valid because organic matter is also lost in addition to the water.

After the sample has been dried, it is weighed. The weight of the water removed is the difference between the weight of the wet sample and the weight of the dry sample. The sample is dried again until the weight of water removed is less than 1 percent of the original weight such that:

$$\frac{\text{wet weight} - \text{dry weight}}{\text{original weight of sample}} \times 100 < 1 \quad [2-34]$$

The moisture content can then be determined based on a wet or dry basis:

$$\text{moisture content (\% wet basis)} = \frac{\text{wet weight} - \text{dry weight}}{\text{wet weight} - \text{container}} \times 100 \quad [2-35]$$

$$\text{moisture content (\% dry basis)} = \frac{\text{wet weight} - \text{dry weight}}{\text{dry weight} - \text{container}} \times 100 \quad [2-36]$$

Fixed solids are defined as the weight remaining after ignition of the total solids at 600 degrees Celsius until complete combustion. An alternative is to use a lower temperature of 375 to 425 degrees Celsius to prevent the loss of inorganic solids. The sample should be exposed to these temperatures for a minimum of 8 hours and a maximum of 24 hours.

The moisture content expressed on a fixed solids basis is calculated by:

$$\text{Fixed solids (\% dry basis)} = \frac{\text{wt. dry sample} - \text{wt. remaining upon ignition}}{\text{wt. dry sample}} \times 100 \quad [2-37]$$

$$\text{Moisture content} = \frac{\text{wt. wet sample} - \text{wt. of dry sample}}{\% \text{ fixed solids} \times \text{wt. of dry sample}} \quad [2-38]$$

The water holding or water absorbing capacity of the compost material is also pertinent because the ideal moisture at which a material will compost is related to the water holding capacity of the material. Optimal biological activity occurs at 60 to 80 percent of the water holding capacity (Brinton 1993).

(b) Bulk density

The bulk density of a compost mix is the mass per unit volume of the material. Bulk density of the compost material is measured as opposed to the density of a single particle. It is the mass per unit volume of the material, while particle density is the mass per unit volume of a single particle. For example, if water is added to the material and results in no change in the volume of the material, then the bulk density of the material increases. The particle density, meanwhile, remains constant. Bulk density, therefore, is a measure not only of the material, but also the air spaces within the sample such that it gives an indication of the ability of air to move through the sample. It is a function of the moisture content and compaction of the

material. Bulk density above 1,080 pounds per cubic yard or 40 pounds per cubic foot does not have enough air spaces for adequate airflow. A high bulk density indicates the need for a bulking agent to improve porosity. Bulk density can also indicate the progress of the composting process because it should decrease over the composting period.

In determining the bulk density, the material must be placed into the weighing container with the same amount of compaction as occurs in the pile. This is somewhat difficult to judge, and overpacking or underpacking the container will cause an overestimation or underestimation of the bulk density. The margin for error can be reduced by taking several samples and averaging the results. Equation 2-39 is used for determining bulk density:

$$\text{Bulk density} = \frac{\text{weight of filled container} - \text{weight of empty container}}{\text{container volume}} \quad [2-39]$$

(c) pH and soluble salts

One method of determining the pH and soluble salts content that can be performed using field-test equipment is the saturated paste method. A pH meter and solu-bridge meter, USP grade calcium chloride, a paper or plastic drinking cup, and distilled or deionized water are required for this test.

A sample is prepared for testing by first filling the cup halfway with compost. Next, the appropriate solution is added to the cup in increments while stirring with a spatula or knife. Sufficient solution has been added when a smooth paste has formed that will not lose water when the cup is held on its side. The solution required for the pH test is a 0.01 M solution of calcium chloride. This can be prepared by dissolving a slightly rounded teaspoon of the calcium chloride dissolved in a gallon of the distilled or deionized water. For the test to be accurate for soluble salts, distilled or deionized water must be used for the solution. The paste that is formed must sit for at least 4 hours. Just before the measurements are taken, the paste should be stirred. If the solution has dried, more solution needs to be stirred into a paste. The appropriate measurements can then be taken by placing the pH meter or solu-bridge meter into the sample with the proper solution.

(d) Particle size distribution

Proper particle size distribution needs to be addressed only if the compost is to be sold. Customers want a compost that is free of clods of compost. Compost that is to be used in potting media or for nurseries requires that it has particles no larger than a certain size. In these cases a sieve is used to screen out particles that are larger than desired.

(e) Organic matter content

The three methods that a laboratory may use to determine organic matter are: Walkley-Black, loss on ignition through use of a muffle furnace, and combustion analysis. The Walkley-Black method for determining organic matter content is the standard method that has historically been used. It involves the use of potassium chromate. A more recently developed method is combustion analysis that determines the organic matter content using infrared sensors. This method requires a sample 0.001 gram or smaller and gives the best and highest value. Most laboratories still use Walkley-Black because of the expense of the equipment needed for combustion analysis. Muffle furnaces give the most variation in results. The carbon content can then be determined by ashing a sample and calculating back to Walkley-Black.

(f) Substrate degradability

Just because a compost mix has the correct C:N ratio on paper does not necessarily guarantee that the pile will begin rapid composting. The availability of the nutrients (carbon and nitrogen) is also a consideration and depends on the degradability of the substrate. The basic method for determining substrate degradability is to measure the amount of oxygen consumed by the substrate under conditions that do not cause rate limitations from lack of nutrients, lack of oxygen, inadequate moisture, and unbalanced pH. The pattern of oxygen consumption over time is then used to determine the rate constant for decomposition of the substrate. The instrument used for this test is called a respirometer. Various respirometers include standard BOD bottle, the Warburg instrument, and an electrolytic constant volume respirometer (Haug 1991).

The simplest method for measuring substrate degradability is to use a standard BOD bottle. This bottle is charged with an oxygen saturated solution containing both water and the sample. The oxygen concentration remaining in solution over time determines respiratory consumption. A drawback to this test for degradability is that only a limited amount of oxygen can be dissolved in water. This limits the quantity of the sample that can be analyzed. This method is difficult to apply to solid samples.

A manometric, constant volume respirometer (the Warburg instrument) is often used. It works under the principle that at constant temperature and volume, the change in pressure as measured by a manometer will indicate the change in the amount of gas. This method is limited to small, homogeneous samples and is expensive.

An electrolytic, constant volume respirometer can also be used to measure substrate degradability. These respirometers use water electrolysis to restore the oxygen that is consumed in the reaction vessel. As the pressure in the reaction vessel decreases because of the consumption of oxygen and the absorption of carbon dioxide, an electrolytic cell is set into operation. This electrolytic cell dissociates water into H and O. Oxygen is directed back into the reactor while hydrogen is released to the atmosphere. The quantity of oxygen produced is then determined through measurement of the applied current and its duration. Electrolytic respirometers can range from home-built to computerized and are well suited to analysis of compost substrates. They are also, however, relatively expensive.

R.T. Haug and W.F. Ellsworth's article in the January 1991 issue of *Biocycle*, *Measuring Substrate Degradability*, is an indepth description of setup and use of a constant pressure respirometer (*Biocycle* 1991).

(g) Compost quality

Compost quality is determined by its physical, chemical, and biological characteristics. Because some of these characteristics are somewhat subjective, there is no set method of determining compost quality. The degree of compost quality required is also dependent on the end use and the sensitivity of that end use.

The physical characteristics used to determine compost quality are particle size, texture, appearance, and absence of noncompostable debris. These characteristics are important indicators of compost quality particularly for compost that is to be sold. Characteristics that become less important when the compost is applied to cropland are particle size, texture, and appearance. Particle size is dependent on the end-use. A particle less than 0.5 inch in diameter is generally adequate for potting, potting media amendment, and soil amendment grades of compost. A smaller particle size (<0.25 inch) is necessary for compost of top dressing grade. The texture should be soil-like and the color dark brown to black. The difference in color between composts can often be the deciding factor. The one feature that is important regardless of the end-use is that the compost be free of debris. Customers do not want to find glass, plastic, or other such debris in their compost.

The chemical characteristics of the compost are important to determine its value as fertilizer or a soil amendment, its potential toxicity to plants, and its ease of incorporation. The chemical characteristics of interest are organic matter content, moisture content, pH, metals, nutrients, and soluble salts.

The organic matter content of the compost as determined through laboratory analysis does not necessarily reveal the amount of organic matter that will be contributed to the soil. This depends on the form of the organic matter. Well-degraded humus-like material is the preferred form of organic matter as opposed to undecomposed material, such as wood. The type and amount of organic matter in the compost are especially important if it is being used as a soil amendment to restore organic matter to the land.

The desirable moisture content of the finished compost is within a range of 30 to 50 percent. Compost with a moisture content of more than 60 percent tends to form clumps that are difficult to break apart and, consequently, is difficult to spread evenly over the land. Wet compost is also difficult to handle. The main disadvantage of a dry compost is that it produces significant amounts of dust. Dry compost that is high in organic matter content is also difficult to incorporate into the soil because it tends to stay on the surface of the soil.

The pH of the compost should generally be within a range of 6 to 8. An acidic or basic compost can be detrimental depending on the type of crop grown and the sensitivity of its end use. More specifically, a pH of 5.5 to 6.5 is recommended for potting soil and germination mixes, and a pH of 5.5 to 7.8 for soil amendments, top dress, and mulch (Nilsson 1994).

A laboratory analysis indicates the nutrients present and their amount. Several things about nutrient analysis are important to know. Kjeldahl nitrogen is an important laboratory test because its results can be used to determine the amount of organic nitrogen in the compost. Total Kjeldahl nitrogen (TKN) is the sum of the organic and ammonia nitrogen because the nitrate nitrogen is driven off in the test. If ammonia nitrogen is determined individually, the organic nitrogen can be determined by subtracting the ammonia nitrogen from TKN. A test for nitrate nitrogen is needed to obtain the total nitrogen (TN) for a compost. Total nitrogen is the sum of the nitrate nitrogen and TKN.

The primary form of nitrogen in the compost immediately following the active composting period is ammonium (NH_4^+). In large amounts, NH_4^+ can be detrimental to some horticultural plants. As the compost is allowed to age, this ammonium nitrogen is gradually converted into nitrate-nitrogen. Compost of different levels of maturity should, therefore, be used as appropriate for the species of plants and the stages of growth depending on sensitivity to pH levels and ammonium nitrogen.

Other important nutrients for plant growth are phosphorus, potassium, calcium, and magnesium. These nutrients in mature compost, like nitrogen, also have varying nutrient release characteristics and plant availability. The percentages of nutrients contained in the compost are important as are their ratios in relationship to each other. This is because the ratio of the nutrients can affect nutrient uptake and plant growth. The best example of this is the C:N ratio. If the C:N ratio of the compost is too high when land applied, the soil micro-organisms compete with the plants for the available soil nitrogen for energy to degrade the additional carbon. The resulting nitrogen immobilization may negatively affect the growth of the plants.

The metal content of the compost is important particularly when the compost is used on crops for human consumption. Metal content is a greater concern for composts produced using sewage sludge and municipal waste, particularly those that had brown bags or cardboard as a raw material.

Soluble salts can be harmful to plants by reducing water absorption and producing conditions that are toxic to the plants. When soluble salts cause harm is dependent on the type of salt, the salt tolerance of the plant, and how much compost is applied. For example, salts containing sodium may be more detrimental to a particular plant than potassium salts. A compost high in soluble salts concentration is more detrimental to compost used for potting soil or germination mixes. This is because there is little dilution with large amounts of soil as compared to when compost is used as a soil amendment or land applied to cropland. Potting soils, germination mixes, and topdresses generally require a soluble salts content below 2 to 4 mmhos/cm (Nilsson 1994). When compost is used as a soil amendment or mulch, it is diluted with large amounts of soil or applied to plants that are more tolerant of high salts. Therefore, these compost uses can have a higher soluble salts content, such as 12 mmhos/cm.

A compost having desired physical and chemical characteristics may not be considered a quality compost if the level of microbial activity is too high for the compost to be considered stable. Its use may inhibit the growth of plants because of the continued activity of the micro-organisms competing with the growing plants for nutrients. Compost also may have disease suppressive qualities. The degree to which a compost is suppressive to disease is dependent on the raw material used, the environment in which the material was composted, and the conditions during curing. The degree of maturity of the compost also affects its disease suppressive qualities. Immature composts promote pathogens and can result in increased disease. Highly stabilized compost will not support the micro-organisms responsible for disease suppression—the biocontrol agents (Hoitink, et al. 1994). Research in the use of compost for disease suppression is only in its beginning stages as is the technology. Because consistent disease suppression requires strict quality control, biological control of diseases is mostly limited to composted bark and sphagnum peat.

King County, Washington, specifications for organic amendment for use in public works projects provides example criteria for compost quality. The criteria is:

1. 100 percent shall pass through a 1-inch sieve when tested in accordance with AASHTO T87 and T88.
2. The pH range shall be between 5.0 and 8.5 when tested in accordance with WSDOT Test Method 417.
3. Foreign material (plastic, mineral soils, concrete, metal) shall not be more than 2 percent on a dry weight or volume basis, whichever provides for the least amount of foreign material.

(h) Determination of compost stability

Compost stability has implications for its curing and use. A stable and mature compost is one that has completed the active composting period and has cured sufficiently so there has been further decomposition of organic acids and decay-resistant compounds, the formation of humic compounds, and the formation of nitrate-nitrogen. The use of immature compost for potting media or for land application can damage or kill the plants because of excessive C:N ratio, ammonium-nitrogen, volatile organic acids, or other phytotoxic compounds. A reliable test of compost maturity is required to prevent any damage that may be brought about by the application of immature compost. A test for compost maturity also helps to determine whether a pile is suitable for storage. Several methods are used for measuring the stability of compost, but none has proven to be completely reliable. In addition, these tests are often sophisticated and expensive.

A simple and inexpensive test for determining compost maturity is the Dewar self-heating test (Brinton, et al. 1993). In this test a sample of the compost is taken and cooled to room temperature. It is then put into a Dewar flask, a double-walled vessel with a vacuum between the walls to reduce the transfer of heat. The temperature rise that occurs while the sample is in this flask indicates the stability of the compost. The relation between the rise in temperature and the stability of the compost is inversely proportional such that the more the sample heats, the lower its stability. If the compost sample does not heat to more than 20 degrees Celsius (68 °F) above ambient, then the compost may be stored without any of the

problems caused by high levels of continuing microbial activity (e.g., anaerobic decomposition, odors, production of phytotoxic compounds). Table 2-1 gives the rating and description of stability using the Dewar method to determine compost maturity.

A method developed by Woods End uses the oxidation and reduction (redox) potential of the compost to measure its stability. In this test the redox potential of

a moistened sample is measured and then placed in saturated incubation for 24 hours. The redox potential of a stable material does not change significantly during the incubation period. The greater the fall in redox potential, the lower the stability level. Texture, mineral species present, moisture content, and oxygen supply influence redox potential measurements. The mechanisms of this test are not clearly understood, but a low redox potential indicates low stability since the loss of gaseous nitrogen and odorous compounds occurs only when the redox potential is low. False high readings indicating stability are also possible if conditions are such that decomposition is inhibited. These conditions include extremes in pH (those outside the range of 6 to 9) or a lack of viable organisms to carry out the decomposition because of excessive heating, sterilization, or antibiosis.

Table 2-1 Dewar self-heating method for determining compost maturity*

Heat rise °C (°F) over ambient	Rating	Description of stability
0 – 10 °C (32 – 50 °F)	V	Completely stable compost, can be stored
10 – 20 °C (50 – 68 °F)	IV	Maturing compost, can be stored
20 – 30 °C (68 – 86 °F)	III	Material still decomposing, do not store
30 – 40 °C (86 – 104 °F)	II	Immature, active compost, must remain in windrows
40 – 50 °C (104 – 122 °F)	I	Fresh, very new compost

* Source: WERL: On-Farm Composting: Guidelines for Use of Dairy and Poultry Manures in Composting Formulations. USDA Report, p. 20.

Measuring the decomposition rate as a function of the CO₂ loss rate is another measure of the stability of a compost. The relative amount of organic carbon respired during incubation at 34 degrees Celsius for 24 hours is measured along with the weight loss. A low degree of carbon dioxide respired indicates advanced humification and stability. This test is also used to estimate the nitrogen that will be released upon application. The less stable the compost, the greater the amounts of nitrogen that can be expected to be released into the soil. Table 2-2 shows the stability of compost based on carbon dioxide respired during incubation and the estimated nitrogen that will be released upon application.

Table 2-2 Stability of compost based on carbon dioxide respired during incubation*

Carbon loss % of C/day	mg CO ₂ -C per g C	Rating of respiration	Comments on stability	Soil N-release (estimated)
0.0 – 0.2	0 – 2	very low rate	advanced humification & stability	low < 25%
0.2 – 0.8	2 – 8	moderately low	expected for ripe composts	medium 50%
0.8 – 1.5	8 – 15	medium rate	normal for average manures	medium 50%
1.5 – 2.5	15 – 25	med – high rate	normal for fresh wastes	medium 50%
2.5 – 5.0	>25	high rate	very unstable – odorous!	high > 75%

* Source: WERL: On-Farm Composting: Guidelines for Use of Dairy and Poultry Manures in Composting Formulations. USDA Report, p. 45.

The determination of the presence of volatile organic acids is still another indicator of compost stability. A stable, high quality compost generally does not have volatile organic acids. Examples of such acids are acetic and butyric acid. Their presence is indicative of anaerobic fermentation and instability and are responsible for odors and phytotoxicity. Their presence may be indicative of an unripe, unstable compost, but their absence does not necessarily indicate a stable, mature compost. This test involves a distillation of water-soluble fatty acids at atmospheric pressure. Table 2-3 shows the volatile organic acids ratings.

The best test of compost stability is to observe its effect on plants. Phytotoxicity (poisonous to plants) can result from high levels of heavy metals, toxic compounds, and organic acids as well as problems with oxygen demand of the compost. Table 2-4 give the classifications of compost stability as indicated by phytotoxicity.

Field tests generally are not used to test phytotoxicity because too many variables are introduced. Using indicator plants to evaluate germination and growth of plants in beds of compost is more practical. Cress seed plants are used for this purpose because of their rapid growth rates. Other indicator plants include wheat and lettuce seedlings in peat mixtures. The seeds are planted in the compost. A standard method is to use 100 plug holes for planting the individual seeds. This allows a visual representation of growth inhibition as well as the determination of numerical percentages.

Germination and growth are evaluated over a 5- to 8-day period depending on the type of seed used. The percentage growth must then be compared to control germination rates where seeds are not grown in a compost. A medium control often used is moistened paper towels. The major disadvantage of these tests is that they are not useful for evaluating differences in stability in the early stages of the composting process.

Another method is to evaluate cress seed germination and root elongation in an aqueous extract from the compost during an incubation period of 24 hours at 27 degrees Celsius. A further test of compost stability and phytotoxicity is to test how long the compost can sustain a plant. Radishes and green beans are used for these tests. Radishes are more sensitive while green beans are more tolerant.

The C:N ratio is an indicator of compost stability only up to a point. A compost with a high C:N ratio prevents the uptake of nitrogen by the plants because of the competition between compost micro-organisms and plants for nitrogen. A low C:N ratio, however, is not necessarily an indicator of stability, particularly if the original C:N ratio is low as well. A reduced C:N ratio generally indicates that at least some decomposition and stabilization have occurred.

Another method for determining compost stability is to determine the oxygen consumption rate by measuring the decrease in partial pressure of the oxygen of a sealed vessel containing the compost.

Table 2-3 Volatile organic acids as an indicator of compost instability*

VOA rating	Level of VOA dry basis (ppm)
Very low	< 200
Medium – low	200 – 1000
Medium	1,000 – 4,000
High	4,000 – 10,000
Very high	> 10,000

* Source: WERL: On-Farm Composting: Guidelines for Use of Dairy and Poultry Manures in Composting Formulations. USDA Report, p. 46.

Table 2-4 Phytotoxicity as an indicator of compost stability*

Percent inhibition of plants	Classification of toxicity
81 – 100	I – Extremely toxic
61 – 80	II – Highly toxic
41 – 60	III – Toxic
21 – 40	IV – Moderately toxic
0 – 20	V – Slightly, non-toxic

* Source: WERL: On-Farm Composting: Guidelines for Use of Dairy and Poultry Manures in Composting Formulations. USDA Report, p. 46.

Other possible tests that have the potential to be effective are those that analyze the disappearance of starch, 5-day biochemical oxygen demand in aqueous suspension, nitrogen transformations, and chemical oxygen demand (COD). These methods are all potentially effective in determining compost maturity, but require sophisticated analytical techniques.

637.0210 Composting methods

Several composting methods are applicable to farm operation. The method chosen is dependent on the quality, capital investment, labor investment, time investment, and land and raw material availability. The four broad methods of composting developed for use in large-scale composting are passive piles, windrows, aerated static piles, and in-vessel systems.

(a) Passive composting piles

The passive composting pile method involves forming the mix of raw material into a pile (fig. 2-6). The pile may be turned periodically primarily to rebuild the porosity. Aeration is accomplished through the passive movement of air through the pile. This requires that the pile be small enough to allow for this passive air movement. If it is too large, anaerobic zones form.

Special attention should be given to the mixing of raw material. The mix must be capable of maintaining the necessary porosity and structure for adequate aeration throughout the entire composting period.

The passive composting method requires minimal labor and equipment. The method is often used to compost leaves. Because aeration is passive, this method is slow and the potential for development of anaerobic conditions is greater. This, of course, increases the potential for odor problems.

Figure 2-6 Passive compost pile

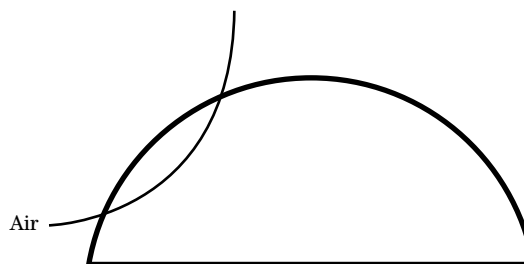

(b) Windrow

The configuration of windrows is elongated (fig. 2-7). These piles are turned regularly. Raw material is either mixed before pile formation or mixed as a part of pile formation. Windrow shapes and sizes vary depending on the climate and equipment and on the material used. Typically, windrows are 6 to 10 feet high, 15 to 20 feet wide, and are up to several hundred feet long. A wet climate requires a windrow shape that allows moisture runoff. A concave top may be required in drier climates to collect water and maintain pile moisture. Smaller windrows experience greater heat loss, while larger piles run the risk of anaerobic zones and odors. Dense material, such as manure, should be piled at a lower height than fluffy material, such as leaves. Bucket loaders and backhoes can produce higher windrows than turning machines.

Windrows are aerated by passive aeration as in the passive composting method. The porosity necessary for adequate passive aeration is maintained by regularly turning the windrows. Turning windrows also serves to mix the material; releases heat, water vapor, and gases; and composts material more evenly. Because significant amounts of heat are released upon turning the windrow, turning prevents excessive temperature accumulation within the windrow. Turnings are more frequent during the initial stages of composting when the most intense microbial activity takes place and temperature evolution is the greatest.

The schedule of turnings during composting varies from operation to operation depending on temperature levels in the pile, consistency of the manure, labor and equipment availability, season, and how soon the

compost is needed. The turning frequency can range from several times weekly to monthly. The number and frequency of turnings needed to achieve the desired quality compost is best determined through experience.

The amount of time required to finish the composting process using the windrow method ranges from 3 to 9 weeks. The duration is dependent on the type of material being composted and the frequency of the turnings. The more frequent the turnings, the shorter the duration will be. For a 2-month composting period, five to seven turnings are typical. Curing generally lasts at least 1 month.

Commonly available farm equipment can be used for the initial mixing and pile formation and for turning. Most windrow operations use bucket loaders for mixing, pile formation, and turning. Manure spreaders are used to construct windrows. Backhoes, grapple loaders, potato diggers, and snowblowers are also used. Dump trucks, dump wagons, and bucket loaders can be used for pile formation and material transport. Specialized windrow turners are available. The windrow method is the most widely used by farmers because of its adaptability and flexibility to farm operations and its ability to produce quality compost.

(c) Passively aerated windrows

Passively aerated windrows (fig. 2-8) are not turned. Aeration is accomplished solely through the passive movement of air through perforated pipes embedded in the base layer of the pile. Another feature that distinguishes this method from turned windrows is the use of a base layer and a top layer in windrow construction. The base layer is typically composed of peat moss, straw, or finished compost. The main characteristic desired of this layer is that it be porous so that the air that is coming through the pipes is evenly distributed. It also helps to insulate the pile and absorb moisture.

The top layer is composed of peat moss or finished compost and serves several functions. The first function is to retain odors through the affinity of peat moss and finished compost for the molecules that cause odors. The top layer also deters flies and retains moisture and ammonia.

Figure 2-7 Windrow method

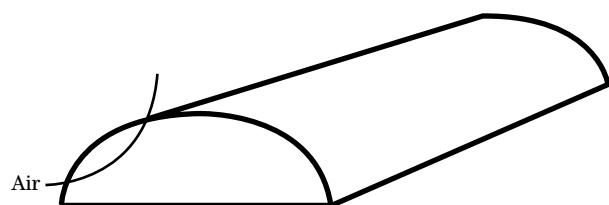

Initial construction of this type of windrow requires more labor than other windrow methods. Once the windrow is formed, however, the labor requirement is primarily that necessary to monitor the temperature and porosity of the pile.

As in the passive composting system, the key element is to formulate a mix with good porosity and structure to allow for adequate aeration. Peat moss has been the primary amendment with this method because of its good porosity and structural qualities. Passive aeration also requires that the piles not be as high as those are for the windrow method. The typical height is 3 to 4 feet with a width of about 10 feet. The bottom and top layers should each be about 6 inches thick.

(d) Aerated static pile

A variation on the passively aerated windrow method is the aerated static pile (fig. 2-9). The main difference between a passively aerated windrow and an aerated static pile is that the aerated static pile uses blowers that either suction air from the pile or blow air into the pile using positive pressure.

The suction method of aeration allows better odor control than positive pressure aeration, particularly if the air is directed through an odor filter. An odor filter is essentially a pile of finished compost that has an affinity for odor-causing molecules. Some other odor-treatment system can also be used to treat the air

coming out of the pile. The disadvantage of using suction is that not as much air can be pulled through the pile as can be pushed through using positive pressure.

The blowers used for aeration serve not only to provide oxygen, but also to provide cooling. Blowers can be run continuously or at intervals. When operated at intervals, the blowers are activated either at set time intervals or based on compost temperature. Temperature-set blowers are turned off when the compost cools below a particular temperature. Blower aeration with temperature control allows for greater process control than windrow turning.

A forced aeration static pile has a base layer and top layer much like the passively aerated windrow. The purpose of the base layer for the aerated static pile is to distribute air evenly either as it enters or leaves the aeration pipes. This requires porous material, such as wood chips or straw. The top layer is generally composed of finished compost or sawdust to absorb odors, deter flies, and retain moisture, ammonia, and heat.

As with all static piles, the initial mix and pile formation must have proper porosity and structure for adequate air distribution and even composting. A decay-resistant bulking agent is required to provide the necessary porosity. Wood chips are a good example of a bulking agent. They undergo minimal degradation during the composting process and can be screened from the finished compost and reused.

Figure 2-8 Passive aerated windrow

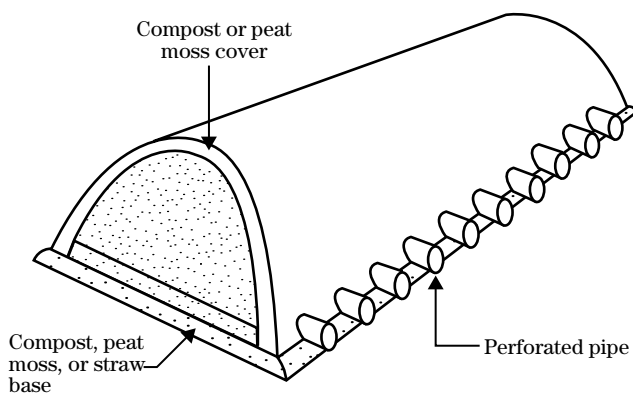
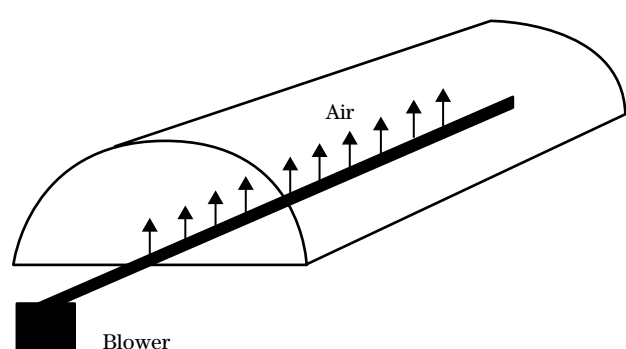

Figure 2-9 Aerated static pile



The use of forced aeration also requires additional calculations. The size of the blower as well as the number, length, diameter, and types of pipes to use for adequate aeration must be determined. Pipes and blowers interfere with pile formation and cleanup operations. Aerated static piles are not commonly used for farm-scale composting operations.

(e) In-vessel systems

(1) Bin

Bin composting (fig. 2-10) uses either constructed wooden bins, unused storage bins, or some other appropriate vessel either with or without a roof. Some bins have aeration systems similar to those of forced aeration static piles. The same principles as forced aeration piles apply to these. The material in nonaerated bins must be turned regularly to maintain aerobic composting.

(2) Rectangular agitated bed

The rectangular agitated bed method (fig. 2-11) uses long, narrow beds in which to compost and an automated turner for periodic turning. The turner is supported on rails that are mounted on either side of the bed for its whole length. As the turner moves along the bed, the compost is turned and moved a set distance until it is ejected at the end of the bed. In some systems blowers are also used to force air into the beds.

Figure 2-10 Bin

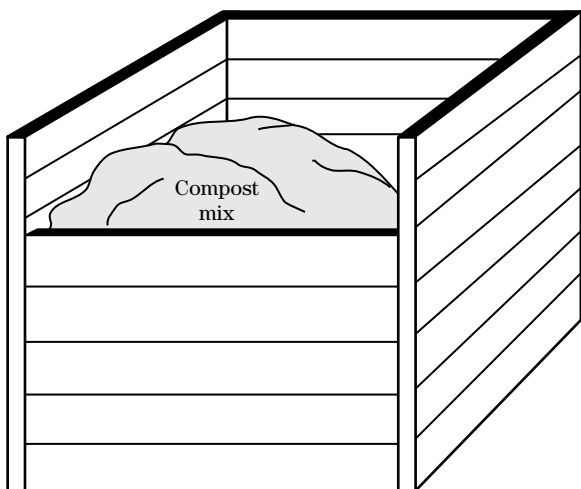

The duration of the composting process is determined by the length of the bed and the turning frequency. An extended curing period is generally required.

(3) Silo

The silo method (fig. 2-12) is a rapid composting method that requires a prolonged curing stage. Compost material is loaded into the silo at the top and removed from the bottom using an auger. Aeration is provided through the base of the silo so that air is forced upward through the compost material. Outlet air can be collected from the top and directed to an odor treatment system, such as a biofilter.

(4) Rotating tube

The rotating tube (fig. 2-13) is a method that can be used where small amounts of waste require composting. The compost mix is loaded in the upper part of the tube. The mix will rest on the first baffle plate. When the tube has filled from the first baffle plate to the top

Figure 2-11 Rectangular agitated bed system

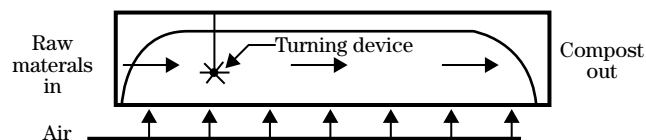
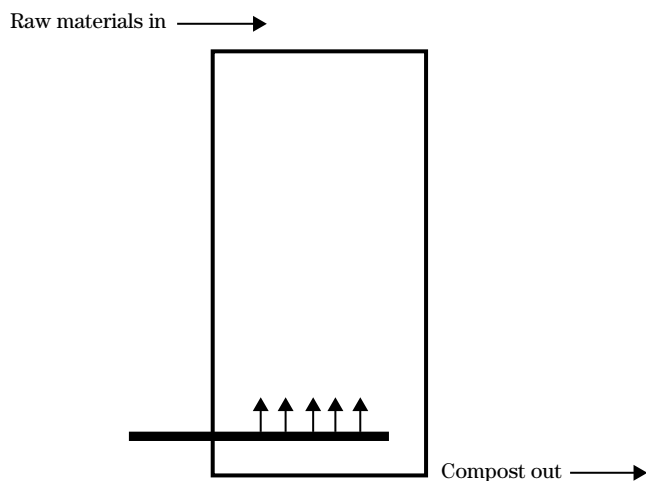

Figure 2-12 In-vessel silo



of the tube, it is rotated to aerate the compost mix and empty the tube above the first baffle plate. This allows additional compost mix to be loaded in the tube. Ideally, the tube is operated so the composting process is complete by the time the material exits the tube. Tube size will be limited to what can be rotated when it is filled to capacity.

(f) Comparison of composting methods

The advantages and disadvantages each composting method is briefly summarized in this section.

(1) Passive composting piles

Advantages:

- They require the least management.
- Once the piles are formed, they need only be turned occasionally to restore porosity.
- They have low capital costs. The equipment needed to mix the raw material and form the piles can be adapted from farm machinery already in use.

Figure 2-13 Rotating tube composter

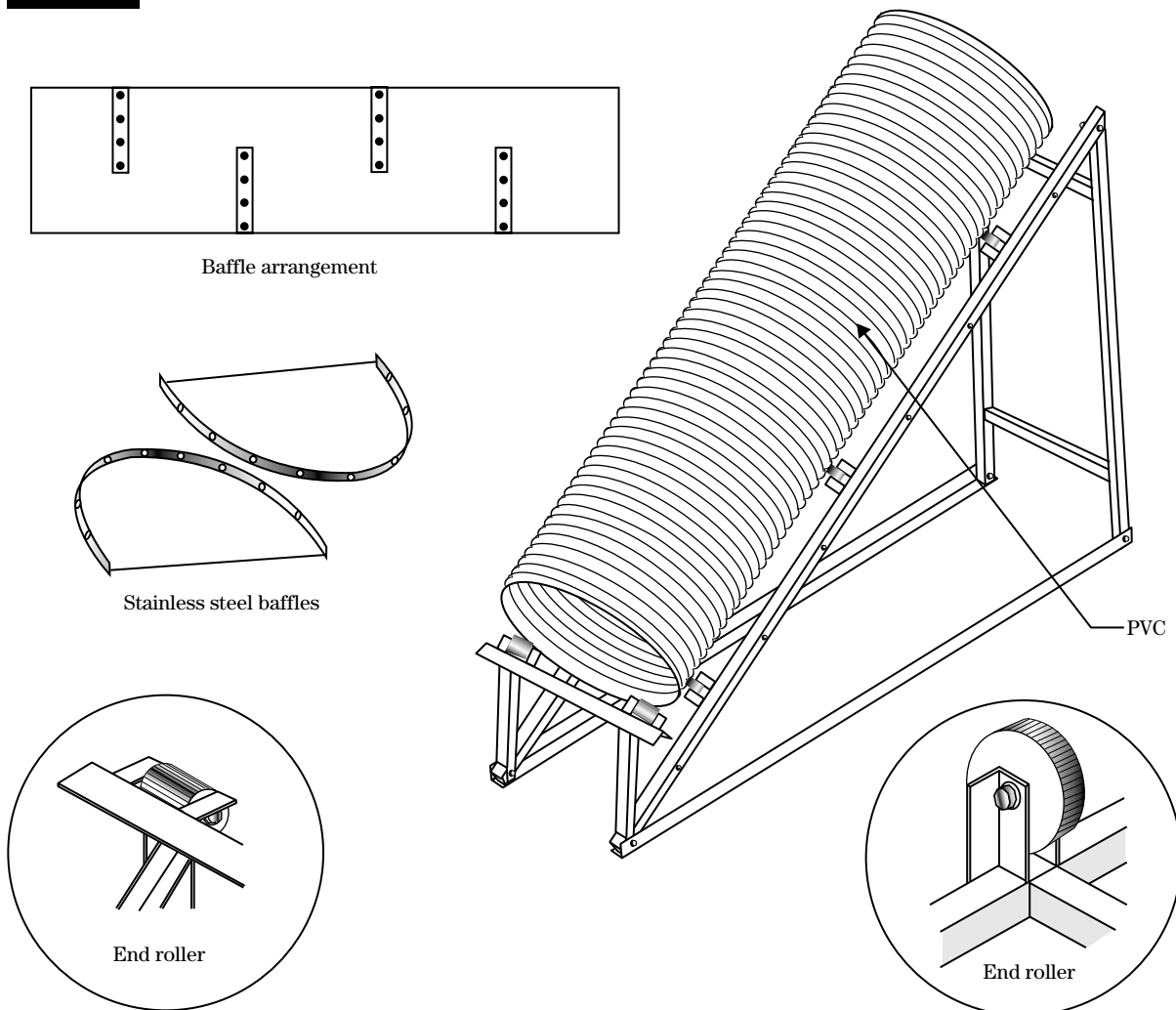

Disadvantages:

- The composting process is very slow because aeration is passive and turnings are infrequent.
- Up to 1 year is required for the compost to become fully mature.
- The potential is greater for development of odors because of the increased chance of anaerobic conditions brought about by compaction and lack of adequate aeration.
- The piles must be smaller than for other methods to promote aeration that results because of space inefficiency.
- Because the piles generally are built without any protective covering, they are subject to the effects of weather conditions. Cold weather can slow the process, while heavy precipitation can ruin pile porosity and cause runoff and leaching. Excessive drying also stops the composting process.

(2) Windrow method**Advantages:**

- It is highly adaptable to common farm operations. Already available facilities and equipment can be used to implement the windrow system.
- Flexibility of the turning schedule allows adjustments in the operation according to labor, equipment, and material availability.
- Electricity is not required for this method, so it can be used in remote areas. This allows siting that provides adequate buffering between the compost operation and neighbors and decreases the chance for nuisance complaints.
- They are periodically turned, so porosity and structure of the mix are not as critical, which allows a greater choice of amendments.
- Decreased need for secondary operations to further stabilize the compost.
- Curing can be accomplished.
- Has the capacity to handle large amounts of raw material if adequate land is available for the piles.
- Turning the piles contributes to greater drying and material separation (smaller particle size, finer texture) than a static pile, which increases the quality of the of the finished product.

Disadvantages:

- Similar to those of passive composting piles.
- The open field or area location makes the piles subject to weather conditions, particularly precipitation and cold weather.

- Excess moisture in the pile can lead to anaerobic conditions that generate odors.
- The need for turnings, particularly in the initial stages, makes this method labor intensive.
- Pile turning can take significant time although it depends on the skill of the operator and the type of equipment used.
- Requires more management than other methods because turnings must be frequent enough to maintain porosity and thermophilic temperatures.
- Odors can be a problem, particularly after turning the piles.
- Significant amounts of land and equipment are needed. Land is required both for the piles, and for movement of equipment and material on the compost site.
- Equipment maintenance costs can accumulate because of increased wear and tear on the machinery.

(3) Passively aerated windrows**Advantages:**

- Turning is not required.
- The top layer of straw or finished compost provides odor and nutrient retention.
- Less expensive than forced aeration piles because the purchase of blowers is not required.

Disadvantages:

- They are subject to the effects of the weather.
- They are not appropriate for material that tends to compact during the composting process and requires turning to rebuild porosity.
- The initial mix is critical to maintaining good aeration that limits the material that can be used.
- Perforations in the pipes can become clogged with material so that aeration is inhibited.
- Installation, removal, and damage to the pipes during pile formation and cleanup can be a problem.

(4) Aerated static piles**Advantages:**

- They are more space efficient.
- They can be larger than windrows because aeration is forced rather than passive.
- Space is not needed for turning equipment.
- The increased aeration shortens the time required for composting.

- The time or temperature controlled blowers allow for close process control, which results in less temperature variation and a more consistent quality compost.
- Elevated temperatures increase pathogen kill.
- The insulating layer on the pile helps to achieve higher temperatures as well as prevent excessive losses of ammonia.
- This layer reduces the intensity of odors.
- Require lower capital investment than in-vessel operations that employ forced aeration.

Disadvantages:

- Short-circuiting of the air in the pile can occur, which causes uneven composting and an inconsistent product. It is more likely to happen when the raw material is not properly mixed to obtain good porosity and structure.
- The pipe openings may become blocked, preventing aeration. This is difficult to correct during composting because the pipes are buried at the base of the pile.
- Installation, removal, and damage to the pipes during pile formation and cleanup can be a problem.
- Some capital investment is required to purchase the necessary equipment for blowers and pipes.
- Forced aeration tends to dry the compost pile and, if excessive, will prevent stabilization of the compost.

(5) In-vessel systems

Advantages:

- They are generally located indoors or under a protective cover, which reduces the vulnerability of the compost material to the effects of weather as well as the potential for odor problems.
- Good odor control within the composting facility is possible by diluting the inside air with air from the outside or by directing odors to a treatment system.
- The reduced exposure to the weather allows for greater control of the quality and consistency of the product.
- They are space efficient. Rectangular agitated bed or channel composters are space efficient because they use an automated turner that is mounted on channels. Bins and silos are space efficient because their containment walls allow the material to be stacked higher than static piles or windrows.

- Except for bins, these systems require less labor than windrows because they use an automated turning process or a self-turning mechanism.

Disadvantages:

- The high capital and operation and maintenance costs associated with the required automated turners.
- Breakdown can delay composting if equipment repairs cannot be made quickly.
- Silo and rectangular agitated bed systems encourage shorter composting periods; however, the resulting product may not be fully stabilized or have adequate pathogen kill.
- Bins filled too high can result in compaction and inadequate aeration.
- These systems have less flexibility than other systems, particularly concerning location and equipment.

(g) Controlled microbial composting

Several management approaches are used in farm scale composting operations. One approach is to manage the composting facility based on intuition, experience, and trial-and-error to develop a system that works best. Another approach, and perhaps a better one, is to manage the compost facility from a scientific point of view. This method is called controlled microbial composting. It requires extra time, effort, and input of material to provide an optimum environment for growth of desired composting microbes. Also required are regular monitoring and the use of specialized equipment and material. However, investing the time and money necessary for this system results in a good quality finished compost within a 6-week period. Quality compost can be produced without using the controlled microbial composting method; however, it must be recognized that it generally takes longer.

Controlled microbial composting is carried out using a windrow system. A mix of material is first developed such that the desired microbial population is established. This includes the addition of a microbial inoculant to ensure the presence of the desired microorganisms. Clay and a soil high in organic matter are also added. The clay is responsible for chelating (flocculating) the compost material to improve the texture

and particle size of the compost. The purpose of the soil with high organic matter is to help promote the development of the microbial population.

The compost pad generally is not modified with such material as gravel or concrete. Pile contact with the soil promotes and maintains the microbial population within the pile. The pile is formed by laying down material in layers and mixing it using a specialized windrow turner. Self-propelled and tractor-pulled turners can be used with this method. Some turners include a watering system that wets the pile as it is turned. The windrows formed are generally 3 feet high with widths approximately twice the height or as constrained by the type of windrow turner being used.

Once the pile is formed, it is covered with a special material, generally referred to as fleece, composed of 100 percent polypropylene. This material is resistant to pH levels ranging from 2 to 13 as well as microbiological attack. It helps to maintain optimum conditions within the pile by protecting the pile from adverse environmental conditions. The cover repels precipitation and prevents drying by reducing the effects of sun and wind. It also possesses some insulation qualities that reduce the drop in pile temperature caused by low ambient temperatures. Despite these qualities, the porosity of the cover is such that the necessary exchange of gases between the pile and the surrounding air is not inhibited.

Windrows are monitored regularly for temperature, carbon dioxide, oxygen, and pH. Ideally, the windrows are monitored on a daily basis and sometimes even more frequently during the initial stages of the active composting period. The pile is generally turned when carbon dioxide levels exceed 20 percent or when oxygen levels drop below 5 percent. The pile is also turned when the temperature exceeds 160 degrees Fahrenheit or if the pile begins to cool prematurely. The pile must be turned daily or more often during the first several days through the first week of the active composting period and less frequently as the composting process continues.

Extensive testing may be performed on the final compost product. Tests include pH, nitrates, ammonium nitrogen, total Kjeldahl nitrogen, phosphates, and sulfides. Other tests may be required for specialized uses of the compost. Kits are available to perform basic testing in the field. This precludes the need for laboratory testing in many cases.

Because controlled microbial composting is a labor and equipment intensive method, it is not suitable for many farm operations. Even those farm operations that do use this method precisely, often use it in a modified form to better fit availability of labor and time. For example, the pile may not be monitored or turned as often as is technically required. However, microbial inoculants are used and temperature and carbon dioxide are monitored. This saves the expense of purchasing oxygen and pH sensing equipment and labor required to make these tests.

The extra time, labor, money, and equipment required for this method does pay off because the final product is of very good quality, particularly in terms of texture and appearance. This method also produces this quality product in a shorter period than a less intensively managed system. Good quality compost is particularly important if it is being produced to sell. If, on the other hand, the compost is being produced with the intent to applying it onfarm, quality and appearance may not be as great an issue. For compost to be used onfarm, it is often not necessary or practical to use such a labor-intensive system.

637.0211 Dead animal composting

(a) General

Composting dead animals is an excellent alternative to the traditional methods of their disposal, particularly burning and burying. It provides an environmentally safe and relatively inexpensive method of converting the carcasses into a useful and often marketable product. The composting system for this purpose is easy to implement and requires minimal labor, time, and capital investment.

Dead animal composting has mostly been directed toward broiler mortality, but has also been used to successfully manage swine, turkey, and even bovine mortality. To ensure complete decomposition of larger animals requires a longer composting period. A way to shorten the time required is to make cuts in the larger

muscles and open the gut to increase the surface area exposed to biological activity.

The most used method for dead animal composting is the bin method. It can be either a single stage or two-stage method that uses primary and secondary bins. The single stage method is recommended for smaller operations that do not have the necessary equipment, such as front-end loaders available. The two-stage method is recommended for those operations that have a high mortality and the necessary equipment for the composting operations. A third stage may be necessary for larger animals, such as turkeys and mature swine.

Material is loaded into the primary bin (fig. 2-14) in layers (fig. 2-15). The temperature rises to highs between 135 and 150 degrees Fahrenheit within 2 to 4 days and remains elevated for several days. Once the temperature begins to cool from the peak temperature, usually within 7 to 10 days, the material is unloaded from the primary bins. The material from the primary bins is then either loaded into the secondary bins or,

Figure 2-14 Dead bird composter

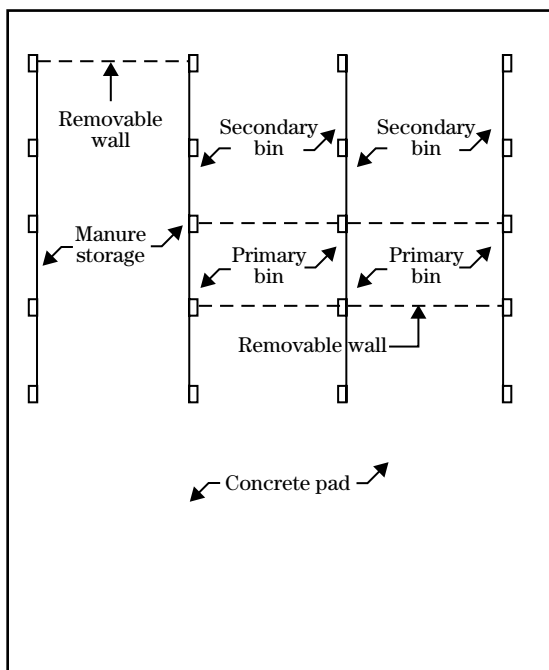

Plan view

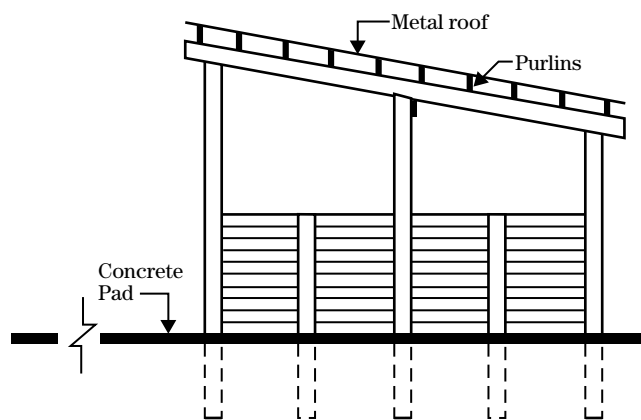

Elevation side view

for single-stage operations, placed in curing piles. The material in the secondary bins reheats and cools after 7 to 10 days. Curing is generally done in an enclosed storage area or outside under a protective tarp. This allows new material to be loaded into the secondary bins. The finished compost can be sold or applied to the land.

The recipe for dead animal composting should be formulated so that a C:N ratio between 13:1 and 15:1 and a moisture content of 40 to 60 percent are obtained. Dead animal bodies have a low C:N ratio. Poultry manure, often used in the recipe for dead

animal composting, also has a low C:N ratio unless it contains a significant amount of bedding material. To achieve a recipe having the recommended C:N ratio, a carbon amendment must be added to the mix. Straw or sawdust is generally used.

The carbon amendment can be omitted from the mix to reduce costs. Without it, however, the mix has a reduced C:N ratio with decreased aeration, and the ammonia odor increases upon mixing. As such, composting without the carbon amendment results in a tradeoff of decreased expenses for increased odors as well as the risk of incomplete composting. This

Figure 2-15 Dead bird bin composting schematic

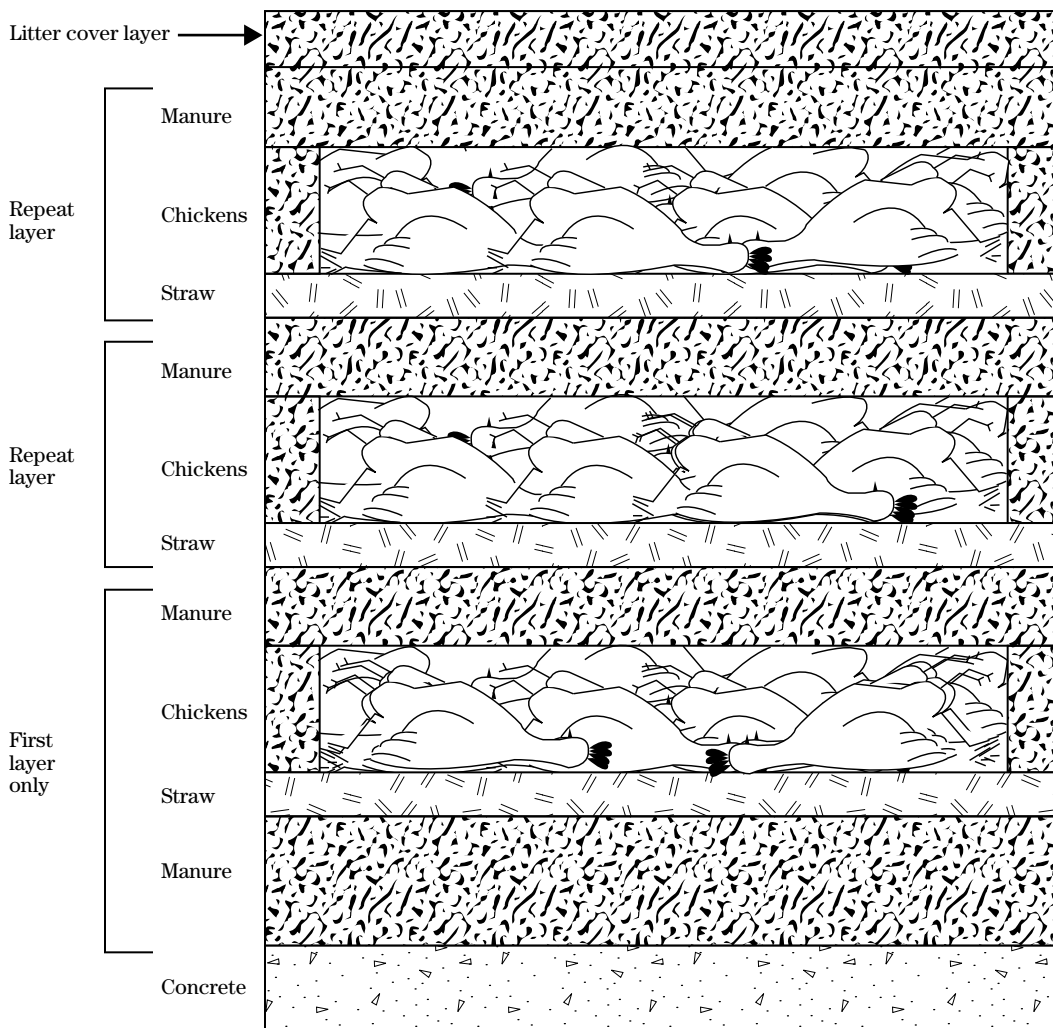

incomplete stabilization also results in decreased compost quality and possibly inadequate pathogen destruction if the temperature is not maintained above 130 degrees Fahrenheit for 15 to 20 days.

Dead animal composting facilities should be sited where drainage and ingress and egress are good. For bin composting, a permanent structure, such as bins constructed of treated lumber or concrete, within a pole-frame building with concrete floors is the most desirable. This type facility offers easier overall operation and management, especially during inclement weather, and is more aesthetic (fig. 2–15). Bins can also be constructed of bales of low-quality hay. This type of construction is less expensive and provides flexibility that a permanent structure would not have, such as the number of bins and their location. Bale bins can also be used along with a permanent structure facility to provide additional composting capacity when the need arises. These bins are constructed with large round bales (5 to 6 feet in diameter placed end-to-end to form walls for three-sided enclosures). Some states may require that composters be roofed.

Compost produced from dead poultry or other animals is generally lower in nitrogen than broiler litter because of losses through denitrification and volatilization. It is higher in P_2O_5 and K_2O than broiler litter because of the reduction in volume that is typically 25 to 30 percent and a mass reduction of about 15 percent.

(b) Dead poultry and small animal composting

The following guidelines for composting dead poultry are adapted from those developed by Auburn University for the NRCS based on their study (McCaskey 1993):

- Use only approved plans for construction of compost facilities.
 - Provide 200 cubic feet of primary bin capacity per 20,000 birds on hand and an equal amount of secondary bin capacity. For example, a poultry producer with a flock of 40,000 birds per brood would need 400 cubic feet of primary bin and 400 cubic feet of secondary bin capacity.
 - Remove poultry mortalities daily from poultry houses.
 - Use one of the following recipes (amounts are expressed as parts per weight basis):
 - With carbon amendment (peanut hulls or chopped hay or straw)

Litter	3 to 4 parts
Carbon amendment ...	0.2 to 0.4 parts
Mortalities.....	1 part
Water	0.5 to 1 parts
 - Without carbon amendment

Litter	4 to 6 parts
Mortalities.....	1 part
Water	0.75 to 1 parts
- Compost ingredients should be added to achieve about 30 to 40 percent moisture in the initial mix regardless of recipe used.
- Monitor compost to see that a temperature greater than 122 degrees F for at least 5 days as an average throughout the composting mass is achieved. This temperature and time criterion can be achieved during either the primary or secondary composting stages or as the cumulative time of greater than 122 degrees Fahrenheit in both stages.
 - Leave primary compost in the bin until the temperature reaches its maximum and then shows a steady decline for 1 week. If the maximum temperature during primary composting is less than 122 degrees Fahrenheit, the compost should be mixed and aerated to encourage heating. This is accomplished by moving the compost to the secondary bin. This step, mixing and aeration, should be repeated until the compost has achieved at least 5 days of temperatures greater than 122 degrees Fahrenheit. Generally, heating during primary and secondary composting is adequate. When the compost has achieved a temperature greater 122 degrees Fahrenheit for at least 5 days, the composting process is adequate to eliminate the bacterial pathogens *Listeria monocytogenes*, *Escherichia coli* 0157:H7, and *Salmonella typhimurium*.
 - Store stabilized compost until it is convenient to land apply it or prepare it for sale to others. Use the secondary bin for stabilized compost storage or remove the compost from the secondary bin and place it in a facility where it is protected from the weather. Compost to be land applied should be tested for N-P-K and applied at rates appropriate for the type of crop grown.

(c) Dead swine and large animal composting

Determining the size of a dead swine composting facility is similar to sizing a poultry composting facility. The method is given in a step-by-step fashion below and is illustrated in example 2-1. The best data for herd mortality can be obtained from the swine producer. If information from the producer is not available, the mortality rate and carcass design weight values in table 2-5 should be used.

(1) Method to determine the size of a dead swine composting facility

Step 1. Determine the weight (lb) of dead animals per year for each size of animal using the following equations.

Baby pigs:

$$S \times LPS \times PPL \times MR \times DW = PDA$$

where:

- S = number of sows
- LPS = number of litters per sow
- PPL = pigs per litter
- MR = mortality rate (% expressed as decimal)
- DW = design weight (lb)
- PDA = weight of dead animals (lb/yr)

Sows nursery pigs, boars and finishing hogs:

$$S \times MR \times DW = PDA$$

Table 2-5 Mortality rates and design carcass weights for determining the size of a dead swine composting facility

Animal type	Mortality rate (%)	Design weight (lb)
Baby pigs 2 litters/sow/year 10 piglets/litter	20	5
nursery pigs	2-3	50
sows	6	400
boars		550
finishing hogs	2	220

Step 2. Determine the average weight of dead animals per day (AWDAD):

$$\frac{TPDA}{365 \text{ days}} = AWDAD$$

Step 3. Determine the primary bin size for the composting facility. Primary bin size for composting dead swine can be determined using one of two volume factors (VF).

- When sawdust is used as the composting carbon source with no added nitrogen source, VF = 20 cubic feet per pound of dead animal per day (Fulhage 1992).
- When sawdust is used as composting carbon source and poultry litter, swine manure, or other nitrogen source is added to adjust the carbon-to-nitrogen (C:N) ratio, VF = 10 cubic feet per pound of dead animal (Henry 1995).

Sample using sawdust as a carbon source with no nitrogen source added:

$$AWDAD \times VF = TPV$$

where:

- AWDAD = average weight of dead animals per day (lb/d)
- VF = volume factor
- TPV = total primary bin volume required

The typical height of a compost pile when in an open (hay bale) facility is 4.5 feet, thus the floor area of a single primary bin is:

$$\frac{TPV}{CH} = PBFA$$

where:

- TPV = total primary bin volume required
- CH = height of compost pile
- PBFA = primary bin floor area (for a single bin)

The second and third stage bins require the same volume as the first stage bin.

(2) Loading the first stage bin

A typical stage one composting bin is loaded using the following sequences according to type of facility and the materials used for composting.

Composting with no nitrogen adjustment:

Sawdust is layered with the dead animals for composting according to the recipe in table 2-6. The first layer is 1 foot of sawdust. To speed composting and prevent excess bloating, an incision should be made into the abdomen of any pig larger than 50 pounds. After each pig is placed in the composter, it is covered with 6 inches of sawdust. The sawdust is sloped so that runoff will be directed from the facility. When the bin reaches a height of 4.5 feet, a 6-inch minimum layer of sawdust is placed on top and sloped to shed water.

The C:N ratio of the mixture in table 2-6 is approximately the carbon source with a minimum of 6 inches of 300:1, which is the C:N ratio for sawdust (Henry, 1990). This is much higher than that desired for dead animal composting because no outside nitrogen source is used.

Composting with a nitrogen adjustment

The composting process will be more efficient if the nitrogen concentration in the mixture is adjusted. Table 2-7 shows the recipe for composting dead swine when poultry litter is used to adjust the carbon-to-nitrogen ratio.

The C:N ratios of two mixtures above are 15:1 for sawdust and 17:1 for straw. These ratios are lower than typical composting C:N ratios of 25:1. However, they correspond with values for dead animal composting in the NRCS, Agricultural Waste Management Field Handbook (NRCS, 1992).

Loading sequence when composting with litter

A typical stage one composting bin is loaded using the following sequence and according to the prescribed mix in table 2-7:

- 1 foot of dry litter is placed on the floor of the bin to soak up excess moisture. This is not part of the recipe in table 2-6.
- A 6-inch layer of carbon source/bulking agent is placed on top of the manure to aid aeration under the carcasses.
- A uniform layer of carcasses is added on top of the carbon source with a minimum of 6 inches of litter added next to the sidewalls to keep the carcasses away from the sidewalls.
- A minimum of 6 inches of litter is immediately added to cover the top of the carcasses.
- The second and each subsequent combination of carbon source, carcasses, and liner (batch) starts with a layer of carbon source, then a layer of carcasses, and then a layer of litter added in proportion required in the prescribed mix (table 2-5). A minimum of four bins should be planned for proper sequencing of the composting process.
- When the loading of the primary bin is completed an additional 6-inch cap of litter is added to the top of the compost mix. This 6 inches of litter is in addition to the litter that was added to the top of the last batch.

Table 2-6 Mix for composting dead swine with sawdust

	Weight ratio	Volume ratio
Sawdust	1.5	5.5
Carcasses	1.0	1.0
Water ^{1/}		

^{1/} Water is added as needed to maintain a damp sponge consistency.

Table 2-7 Mix for composting dead swine with broiler litter using sawdust/straw as a carbon source and bulking agent

	Weight ratio	Volume ratio
Sawdust/straw	1.0/0.3	3.0/1.0
Litter	2.0	4.0
Water	0.7	0.5
Carcasses	1.0	1.0

Example 2-2 Determining the size of a dead swine composting facility

Given: A hog operation having 300 sows. Sows have 2 litters per year with 10 pigs in each litter.

Required: Determine the bin size for a dead swine composting facility using sawdust as carbon source. Additional nitrogen from another source will not be added to compost mix..

Solution:

1. Determine total weight of dead animals per year using data from table 2-5:

Baby pig mortality

$$\begin{aligned} \text{PDA} &= S \times \text{LPS} \times \text{PPL} \times \text{MR} \times \text{DW} \\ &= 300 \text{ sows} \times 2 \text{ litters/sow} \times 10 \text{ pigs/litter} \times 0.20 \times 5 \text{ lb/pig} \\ &= 6,000 \text{ lb} \end{aligned}$$

Sow mortality

$$\begin{aligned} \text{PDA} &= S \times \text{MR} \times \text{DW} \\ &= 300 \text{ sows} \times 0.06 \times 400 \text{ lb/sow} \\ &= 7,200 \text{ lb} \end{aligned}$$

$$\begin{aligned} \text{TPDA} &= \text{Baby PDA} + \text{Sow PDA} \\ &= 6,000 \text{ lb} + 7,200 \text{ lb} \\ &= 13,200 \text{ lb} \end{aligned}$$

2. Determine the average weight of dead animals per day:

$$\begin{aligned} \text{AWDAD} &= \text{TPDA}/365 \\ &= 13,200 \text{ lb}/365 \text{ days} \\ &= 36.2 \text{ lb/day} \end{aligned}$$

3. Determine primary bin size for composting facility

$$\begin{aligned} \text{TPV} &= \text{AWDAD} \times \text{VF} \\ &= 36.2 \text{ lb/day} \times 20 \text{ ft}^3/\text{lb} \\ &= 724 \text{ ft}^3 \end{aligned}$$

The second and third stage bins require the same volume as the primary bin. The third stage volume could possibly be reduced by 15 percent. However, this would limit use of this bin for the third stage only.

Using a compost pile height of 4.5 feet, the floor area of the bin would be:

$$\text{Floor Area} = 724 \text{ ft}^3 / 4.5 \text{ ft} = 161 \text{ ft}^2$$

637.0212 Operational costs

The costs involved in the production of compost vary considerably depending on the material, method, equipment, and final use of the compost. These costs should be analyzed before implementing a compost operation to determine economic feasibility.

(a) Availability and price of raw material

The main raw material for most onfarm composters is manure or dead animals. Other onfarm material can be used as amendments, such as crop residue and spoiled straw. Just about any waste produced onfarm that would have high disposal costs or that presents handling difficulties should be considered. Composting this material reduces costs and improves its handling properties. The advantage of obtaining most or all of the raw material from onfarm is that material costs are generally minimal.

Potential off-farm sources of raw material include other farms, municipalities, racetracks or stables, and food, fish, or wood processors. Preferable off-farm material is available either free or with a tipping fee and is compatible with a composting operation. Municipalities often pay a tipping fee to the compost operator for yard waste, such as grass and leaves and for cardboard and paper. The magnitude of the tipping fees varies depending on the cost of other methods of disposal available to the municipalities.

The cost of wood chips and sawdust varies depending on the supply and competition for other uses. Straw that has limited use for other purposes can generally be obtained at nominal prices per bale.

The cost of transportation for raw material must be considered in the evaluation. A material that is free for the taking may not be cost effective if the expense of hauling is excessive and must be paid by the compost facility.

(b) Quantity and price of land available for the composting operation

A production cost is associated with the land occupied by the compost operation. The value and amount of land available influences the type of composting method used. Depending on the method, 1 acre of land can handle anywhere from 2,000 to 10,000 cubic yards of compost per year. If land availability is not a constraint, the method used determines the amount of land needed.

To minimize production costs, the operation should be scaled for the most efficient utilization of equipment and land. For example, if land is scarce or expensive and considerable material is to be composted, a space-saving method, such as the in-vessel system, should be considered. Static pile methods, however, would suit farms with adequate amounts of land and small volumes of compostables. Windrows are good for operations with adequate land and the need to handle large quantities of compost.

(c) Estimated costs of operation/production

After establishing the basic costs, the material, tasks, and equipment that will be used in the compost operation should be well in mind. Using this knowledge, production costs can be estimated to determine the economic feasibility of the operation. If the analysis reveals that it is not economically feasible, adjustments can be made before significant amounts of time and money have been invested into the operation.

Production costs vary considerably from operation to operation and from month to month. This depends not only on the material, operation, and market, but also on other uncontrollable factors, such as costs of labor, fuel, land, and equipment purchase and maintenance. A difficult item to determine is the profit from sale of compost. Compost operations may fail if overoptimistic estimates are used in the evaluation for marketing and sales.

(d) Pre-startup cost

Costs associated with startup generally are one-time costs. These costs include the value of the land to be used and the labor, time, equipment, and capital investment involved in site preparation. Site preparation should include the cost of the planning that must be done to acquire necessary permits. Actual site preparation costs include the necessary grading, surfacing, drainage, and landscaping. Site preparation also includes any necessary surfacing of access roads to the composting site.

(e) Material handling

Material handling is the primary cost in the production of compost. It includes both capital investment and labor and equipment investment. The amount of capital invested in material handling equipment depends on the method used and the availability of onfarm equipment to the composting operations. Equipment needed that is not available onfarm must be obtained. Some automated turning equipment can be quite expensive. The options that could be considered include joint ownership by several farmers, leasing, or purchasing used equipment.

The cost associated with turning the piles must be considered. This cost depends mainly on the volume and bulk density of the material being turned and the equipment used for turning. High volumes and dense material require more time. The cost of turning decreases as the composting process advances because of the reduced volume of the material. The volume decreases by 50 to 80 percent over the duration of the composting period.

The skill and experience of the operator along with the power and size of the machinery also influence the cost. A skilled operator can turn a windrow more effectively and in a shorter period than an inexperienced operator. Specialized windrow turners are often faster and provide a more thorough mixing and shredding of the material than a front-end loader or other adapted farm equipment. The negative aspect to these turners is that they require a large capital investment. If farm equipment is to be used, the increased wear and tear and subsequent maintenance costs also contribute to the operating costs.

(f) Monitoring

Relative costs of monitoring and testing equipment were described previously in the section on monitoring equipment (637.0203(e)).

(g) Operations after completion of composting

If the compost is to be sold, it may require additional processing, such as screening and bagging. Screening is necessary particularly if the compost is to be sold in bagged form. Bagging can be accomplished by hand or by machine. Either method of bagging requires a labor investment and, depending on the machinery used for bagging, a minimal to substantial capital investment. Additional space and a roofed area for longer term curing and higher quality may also be necessary. Permits, licensing, and additional testing and reporting may also be required by regulation if the compost is sold for off-farm purposes.

The primary alternative to selling the finished compost is to apply it to the land. This may also be considered an operational cost of the compost operation.

637.0213 Compost end use

(a) Land application

The many different and often intangible effects that compost can have on soil and plant growth makes it difficult to determine precisely what the application rates should be for land applied compost. The varied qualities and characteristics of the finished compost and the feedstocks used to produce the compost make it difficult to suggest application rates. Ongoing research is extensive on the application of compost to agricultural and horticultural crops. This research evaluates the effects of compost on soil nutrient content, soil conditioning properties, and disease suppression. Compost marketed on the basis of its fertilizer content requires licensing by most State departments of agriculture.

Compost serves its most important function as a soil conditioner through the addition of humus and organic matter to the soil. Humus is the dark, carbon-rich, and relatively stable residue that is a product of the decomposition of organic matter. The addition of humus and organic matter increases the water and nutrient holding capacity of the soil, decreases the soil bulk density, and improves the soil aeration and pore structure. These improvements result from the direct effects of the compost material itself and the indirect effects brought about through the promotion of soil microbial activity and earthworms.

The changes in the soil brought about by the addition of compost stimulate root growth. An increased root system makes a plant more drought resistant because it is able to obtain more water from the soil. The increased root system also allows the plant to increase its nutrient uptake. Increased water and nutrient retention capacities of the soil because of increased organic matter provided by the compost also reduces leaching.

While the main value of compost is in its improvement of soil structure and water holding capacity, compost does contain many nutrients. These nutrients are not present in the same quantities per unit of volume as inorganic fertilizer, however, and will require higher application rates. The advantage of using compost as a

fertilizer is that it releases nutrients slowly, generally under the same warm, moist soil conditions required for plant growth such that nutrient release is matched with plant uptake. This results in a more efficient utilization of nitrogen and a decreased potential for nitrogen leaching. The potential for leaching does still exist when conditions are suitable for nutrient release from the compost, but no plants are available to utilize the nitrogen. This can occur, for example, in early fall after crops have been harvested, but soil moisture and temperature for plant growth and nutrient release are still adequate.

A nutrient analysis of the compost makes known the amount of nutrients present in the compost. However, the analysis does not indicate the amount of nutrients that is immediately available to the plants or how much will be released in subsequent seasons. Various studies have found a wide range of values for the amount of nitrogen available during the first growing season. This variation is attributed to the nitrogen content of compost and its mineralization rates being highly variable. The amount of nitrogen available during the first growing season ranges anywhere from 8 to 35 percent of the total nitrogen, depending on the raw material and method used to make the compost. It is generally assumed that 10 to 25 percent of the nutrients are available during the first growing season. Compost produced from manure generally has a higher nitrogen content than other composts. Of the manures, poultry manure compost has the greatest fertilizer value. While compost applied at reasonable rates may not provide sufficient nutrients to completely replace commercial fertilizers, it can reduce the amount that is normally applied.

Compost has other nutritional benefits. These include provision of a stable supply of ammonium, an increased cation exchange capacity to hold nutrients in the soil, and a buffering capacity to prevent acidic conditions that are damaging to plants.

Compost functions as a disease suppressant by increasing the microbial activity in the soil. The increased number and diversity of soil micro-organisms give beneficial organisms a competitive edge over pathogens. Research for the use of compost as a disease suppressant has mostly been concentrated in the area of composted bark and sphagnum peat because of the need for strict quality control. This is not

a feature of agricultural composting operations. In addition, the use of compost for its disease suppressive quality has been emphasized in container media and nurseries. Chen and Hadar (1986) found that composted separated manure was effective as a peat substitute in container media and was suppressive to soil-borne pathogens, such as *Pythium*, *Rizoctonia*, and *Fusarium*.

Compost application rates vary depending on the mineralization rates and whether the compost is used as a soil inoculate or as a primary nutrient source. Compost applied as a soil inoculate to improve soil tilth and organic matter content should be of high quality and applied at a rate of 2 to 3 tons per acre. When compost is used as a primary nutrient source, the application rate increases to more than 100 wet tons per acre. At 100 tons per acre, the application rate is more than 2 inches thick. It is recommended that application rates not exceed 50 dry tons per acre (4 yd³/1,000 ft²). Compost is generally spread on land at a thickness of 1 to 2 inches. If it is applied at a rate greater than this, it becomes too difficult to incorporate into the soil.

A major concern when applying compost to land is the presence of viable weed seeds in the compost. Of course, weed seeds present in the compost can lead to weed problems. To destroy any weed seeds that may be in the raw material, the compost pile must sustain thermophilic temperatures. It is also possible, however, to recontaminate the finished compost pile with weed seeds. This is particularly a problem if the pile is stored outdoors. To prevent such recontamination, either place the pile under protective covering or in areas where exposure to weed seeds is minimized.

Compost generally has the best effects on plant growth when applied in conjunction with commercial fertilizer. When used alone, compost improves soil and has been shown to increase crop yields and crop height, particularly during the initial stages of growth and during times of drought. The use of an immature compost or one with weed seeds, pathogens, or soluble salts can have a negative effect and promote disease. In addition, potash and phosphorus must not be overapplied when spreading.

(b) Marketing considerations

Marketing places additional managerial demands on the composting operation that may outweigh the potential revenues. However, when a waste must be utilized off-farm, marketing it as compost will be less difficult than marketing the raw material. The main challenges in marketing compost are to establish a market and then consistently meet the quality demands of that market. The successful sale of compost depends on the establishment of an adequate clientele base and then consistently meeting their expectations in both volume and quality.

Many retail stores sell compost produced by large, commercial operations that can produce high quality compost less expensively than smaller agricultural operations. Nurseries and landscapers are also beginning to branch out into composting yard waste and trimmings. The compost market for their products is mostly other landscapers and nurseries. The market for agricultural compost is generally home gardeners. This market is generally local with the compost sold onsite, through local stores, or in bulk to certain buyers. Selling the compost onsite or to selected parties also saves on packaging, advertising, and promotion.

The sale of compost produced on the farm provides an opportunity for another source of revenue. The advisability of selling compost, however, must be carefully evaluated because the additional demands it places on the farm operation may not result in profit when all the costs are considered. In addition, regulations may require the compost to meet certain requirements, especially if it is to be sold as a fertilizer. In some cases nitrogen may be added to the final compost product to increase its fertilizer value.

637.0213 References

- Alcock, Ralph. 1980. An analysis of materials handling at a composting facility. American Society of Agricultural Engineers Paper, St. Joseph, MI.
- Barton, Lionel T., and Raymond C. Benz. Composting poultry carcasses. *In* MP317, Cooperative Extension Service, University of Kansas.
- Bell, R.G. 1973. High-rate composting of municipal refuse and poultry manure. *Canadian Agricultural Engineering* 15(1).
- BioCycle: Journal of Waste Recycling. January 1994, p. 51 (formerly Compost Science and Compost Science/Land Utilization). Published monthly by The JG Press, Inc.
- Brinton, Jr., William F. 1988. Compost demonstration. Time and Tide RC&D.
- Brinton, Jr., William F. Agricultural and horticultural applications of compost.
- Brinton, Jr., William F., and Mary W. Droffner. 1994. Microbial approaches to characterization of composting process. *Compost Science and Utilization* 2(3):12-17.
- Brinton, Jr., William F., and Milton D. Seekins. 1988. Composting fish by-products: a feasibility study. Woods End Research Laboratory, Maine.
- Brinton, Jr., William F., and Milton D. Seekins. 1994. Evaluation of farm plot conditions and effects of fish scrap compost on yield and mineral composition of field grown maize. *Compost Science and Utilization* 2(1):10-17.
- Brinton, Jr., William F., Eric Evans, and Jonathan W.Q. Collinson. 1993. On-farm composting: guidelines for use of dairy and poultry manures in composting formulations. Woods End Research Laboratory, Maine.
- Brodie, Herbert L. 1993. Multiple product compost recipes. American Society of Agricultural Engineers Paper, St. Joseph, MI.
- Brodie, Herbert L., and Lewis E. Carr. 1991. Low input composting of crab waste. American Society of Agricultural Engineers Paper 916004, St. Joseph, MI.
- Buchanan, M., and S. Gleissman. 1991. How compost fertilization affects soil N and crop yield. *Biocycle*, December:72-77.
- Chen, Y., and Y. Arnimelech. 1986. Supply of nutrients by organic additives. *In* The Role of Organic Matter in Modern Agriculture, Martinus Nijhoff Publishers, Dordrecht.
- Chen, Y., and Y. Hadar. 1986. Composting and use of agricultural wastes in container media. *In* Compost: Production, Quality, and Use, M. deBertoldi, M.P. Ferranti, P. L'Hermite, and F. Zucconi, eds., Elsevier Applied Science, NY.
- Compost Science and Utilization. Published by The JG Press, Inc.
- deBertoldi, M., M.P. Ferranti, P. L'Hermite, and F. Zucconi, eds. 1986. Compost: production, quality, and use. Elsevier Applied Science, NY.
- Donald, James O., and John P. Blake. 1992. Dead poultry composter construction. *In* Poultry By-Product Management, Auburn University, Alabama Cooperative Extension Service.
- Donald, James O., John P. Blake, Kevan Tucker, and David Harkins. 1994. Mini-composters in poultry production. Alabama Cooperative Extension Service, Auburn University.
- Emerton, B.L., C.R. Mote, H.H. Dowlen, J.S. Allison, and W.L. Sanders. 1988. Comparison of forced and naturally aerated composting of dairy manure solids. American Society of Agricultural Engineers Paper, St. Joseph, MI.
- Fabian, Eileen A., Tom L. Richard, David Kay, David Allee, and Joe Regenstien. 1992. Agricultural composting: a feasibility study for New York farms. Cornell University, Ithaca, NY.
- Fulhage, C. 1992. Composting Dead Swine. WQ 225. University of Missouri Extension.

- Gillett, James W. 1992. Issues in risk assessment of compost from municipal solid waste: occupational health and safety, public health, and environmental concerns. *Biomass and Bioenergy* 3 (3-4):145-162.
- Goldstein, Jerome, ed. 1991. *The BioCycle guide to the art and science of composting*. The JG Press, Inc., Emmaus.
- Golueke, Clarence G. 1991. Inoculums and enzymes. *In* *The BioCycle Guide to the Art and Science of Composting*. Jerome Goldstein, ed., The JG Press, Inc., Emmaus.
- Golueke, Clarence G. 1991. Principles of composting. *In* *The BioCycle Guide to the Art and Science of Composting*, Jerome Goldstein, ed., The JG Press, Inc., Emmaus, pp. 13-40.
- Gonzalez, J.J., M. Medina, and I.C. Benitez. 1989. Slurry composting options. *BioCycle*, July.
- Goodfellow, M., M. Mordarski, and S.T. Williams, eds. 1984. *The biology of the actinomycetes*. Academic Press, Inc., London.
- Grobe, K., M. Buchanan. 1993. Agricultural markets for yard waste compost. *BioCycle*, September.
- Hammouda, G.H.H., and W.A. Adams. 1986. The decomposition, humification, and fate of nitrogen during the composting of some plant residues. *In* *Compost: Production, Quality, and Use*, eds. M. deBertoldi, M.P. Ferranti, P. L'Hermite, and F. Zucchini, Elsevier Applied Science, NY.
- Hansen, Robert C., Christoph Marugg, Harold M. Keener, Warren A. Dick, and H.A. Hoitink. 1991. Nitrogen transformations during poultry manure composting. American Society of Agricultural Engineers Paper 914014, St. Joseph, MI.
- Hansen, Robert C., Harold M. Keener, and H.A. Hoitink. 1988. Poultry manure composting: system design. American Society of Agricultural Engineers Paper No. 88-4049. St. Joseph, MI.
- Hansen, Robert C., Harold M. Keener, Warren A. Dick, Christoph Marugg, and H.A. Hoitink. 1990. Poultry manure composting ammonia capture and aeration control. American Society of Agricultural Engineers Paper 904062, St. Joseph, MI.
- Haug, Roger T. 1986. Composting process design criteria. *BioCycle* 27:53-57.
- Haug, Roger T. 1990. An essay on the elements of odor management. *BioCycle* October:60-67.
- Haug, Roger T., and W.F. Ellsworth. 1991. Measuring compost substrate degradability. *BioCycle* 32:56-62.
- Henry, S. T. 1990. Composting broiler litter—Effects of two management systems. Clemson Univ., MS Thesis.
- Henry, S. T. 1995. Composting – An innovation in dead swine disposal. ASAE Paper No. 954506. Presented at the ASAE International Meeting, Chicago, IL. ASAE, St Joseph, MI.
- Hoitink, H.A., Y. Inbar, and M.J. Boehm. 1991. Status of compost-amended potting mixes naturally suppressive to soil borne diseases of floricultural crops. *Plant Disease* 75 (9):869-873.
- Hoitink, H.A., and E. Grebus. 1994. Status of biological control of plant diseases with composts. *Compost Science and Utilization*, spring:6-12.
- Jodice, R., and P. Nappi. 1986. Microbial aspects of compost application in relation to *Mycorrhizae* and N-fixing micro-organisms. *In* *Compost: Production, Quality, and Use*, M. de Bertoldi, M. P. Ferranti, P. L'Hermite, and F. Zucchini, eds., Elsevier Applied Science, NY.
- Keener, Harold M., H.A.J. Hointink, Christoph Marugg, and Robert C. Hansen. 1991. Design parameters for in-vessel poultry manure composting. American Society of Agricultural Engineers Paper No. 914001, St. Joseph, MI.
- Laliberty, Lucien. 1987. Composting for a Cash Crop. *In* *On-Farm Composting Conference in U. of Massachusetts*.

- Locci, R., and G.P. Sharples. 1984. Morphology. *In* The Biology of the Actinomycetes, chapter 3, eds. M. Goodfellow, M. Mordarski, and S.T. Williams, Academic Press, Inc., London.
- Logsdon, Gene. 1993. A profit center grows on composted manure. *BioCycle*, November:66-67.
- Logsdon, Gene. 1993. Composting chicken litter in indoor windrows. *Biocycle*, February:60-61.
- Logsdon, Gene. 1993. Manure handling alternative cut costs. *BioCycle*, July:52-54.
- Martin, A.M., J. Evans, D. Porter, and T.R. Patel. 1993. Comparative effects of peat and sawdust employed as bulking agents in composting. *Bioresource Technology* 44:65-69.
- Martins, O., and T. Dewes. 1992. Loss of nitrogenous compounds during composting of animal wastes. *Bioresource Technology* 42(2):103-111.
- McCaskey, T.A. 1993. Dead bird composting. Auburn University.
- Moat, Albert G., and John W. Foster. 1988. Microbial physiology. John Wiley and Sons, New York, NY.
- Nakasaki, Kiyohiko. 1990. Effects of oxygen concentration on composting of garbage. *Journal of Fermentation and Bioengineering* 70(6):431-433.
- Nakasaki, Kiyohiko, A. Watanabe, M. Kitano, and Hiroshi Kubota. 1992. Effect of seeding on thermophilic composting of tofu refuse. *Journal Environmental Quality* 21 (October - December).
- Nakasaki, Kiyohiko, Shigeki Fujiwara, and Hiroshi Kubota. 1994. A newly isolated thermophilic bacterium, *Bacillus Licheniformis* ha1 to accelerate the organic matter decomposition in high rate composting. *Compost Science and Utilization* 2(2):88-96.
- Naylor, L.M., and G. Kuter. Compost: a living fertilizer. *In* Compost Facts, International Process Systems, Inc., Lebanon, CT.
- N'Dayegamiye, A., and D. Isfan. 1991. Chemical and biological changes in compost of wood shavings, sawdust, and peat moss. *Canadian Journal of Soil Science* 71(November):475-483.
- Nilsson, Jon. 1994. Testing for compost quality. *In* The Marketing and Use of Compost in Montgomery County, PA.
- Oshins, Cary, and Lisa Fiorina. 1993. Challenges of on-farm composting. *BioCycle* November:72-73.
- Patni, N.K., L. Fernandes, W. Zhan, and P. Jui. 1993. Passively aerated composting of manure slurry. American Society of Agricultural Engineers Paper, St. Joseph, MI.
- Pereira Neto, J.T., E.I. Stentiford, and D.D. Mara. 1986. Comparative survival of pathogenic indicators in windrow and static pile. *In* Compost: Production, Quality, and Use, M. deBertoldi, M. P. Ferranti, P. L'Hermite, and F. Zucchini eds., Elsevier Applied Science, NY.
- Person, Howard L., and Walid H. Shayva. 1993. A composting process design computer model. American Society of Agricultural Engineers Paper, St. Joseph, MI.
- Ravie, M., Y. Chen, and Y. Inbar. 1986. The use of peat and composts as container media. *In* The Role of Organic Matter in Modern Agriculture, Martinus Nijhoff Publishers, Dordrecht.
- Reider, C., R. Janke, and J. Moyer, 1991. Compost utilization for field crop production. Rodale Institute Research Center, (No. RRC/RU-91/1).
- Richard, Tom L. 1992. Municipal solid waste composting: physical and biological processing. *Biomass and Bioenergy* 3(3-4):163-180.
- Rymshaw, Ellen, Michael Walter, and Thomas Richard. 1992. Agricultural composting: environmental monitoring and management practices. *In* On-Farm Composting Handbook, ch. 6—Management, Robert Rynk, ed., Northeast Regional Agricultural Engineering Service, Ithaca, NY.

Rynk, R. (ed.). 1992. On-farm composting handbook. Northeast Regional Agricultural Engineering Service, Ithaca, NY.

Simpson, Michael. Economics of agricultural composting.

Sobel, A.T., D.C. Ludington, and Kim-Van Yow. 1988. Altering dairy manure characteristics for solid handling by the addition of bedding. *International Agrophysics* 4(1-2): 31-48.

Sterritt, R.M., and J.N. Lester. 1988. Microbiology for environmental and public health engineers. E. & F. N. Spon Ltd., New York.

Sweeten, Childers, Cochran, and Bowler. 1988. Odor control from poultry manure composting plant using a soil filter. American Society of Agricultural Engineers Paper 88-4050, St. Joseph, MI.

van der Werf, P. 1993. Compost as a partial nutrient source. *Biocycle*, February:79.

Weltzien, Heinrich C. 1991. Biocontrol of foliar fungal diseases with compost extracts. *In* *Microbial Ecology of Leaves*, John H. Andrews and Susan S. Hirano, eds., Springer-Verlag New York, Inc., New York.

Williams, S.T., E.M.H. Wellington, and S. Lanning. 1984. Ecology of actinomycetes. *In* *The Biology of the Actinomycetes*, chapter 11, eds. M. Goodfellow, M. Mordaski, and S.T. Williams. Academic Press, Inc., London.

Wistreich, George A., and Max D. Lechtman. 1988. *Microbiology*. 5th ed., MacMillan Publishing Co., New York.

Glossary

(Adapted from the On-Farm Composting Handbook, NRAES-54, Northeast Regional Agricultural Engineering Service, 152 Riley-Robb Hall, Cooperative Extension, Ithaca, NY 14853-5701)

- Actinomycete** A group of micro-organisms, intermediate between bacteria and true fungi, that generally produce a characteristic branched mycelium. These organisms are responsible for the earthy smell of compost.
- Aerated static pile** Forced aeration method of composting in which a freestanding composting pile is aerated by a blower moving air through perforated pipes located beneath the pile.
- Aeration** The process by which the oxygen-deficient air in compost is replaced by air from the atmosphere. Aeration can be enhanced by turning.
- Aerobic** An adjective describing an organism or process that requires oxygen (for example, an aerobic organism).
- Agitated-bed** An in-vessel composting method in which the material is contained in a bin or reactor and is periodically agitated by a turning machine or by augers. Some means of forced aeration is generally provided.
- Agricultural waste** Waste normally associated with the production and processing of food and fiber on farms, feedlots, ranches, ranges, and forests. May include animal manure, crop residue, and dead animals. Also agricultural chemicals, fertilizers, and pesticides that may find their way into surface and subsurface water.
- Ambient air temperature** The temperature of the air near the compost pile.
- Amendment** See Composting amendment and Soil amendment.
- Ammonia (NH₃)** A gaseous compound of nitrogen and hydrogen. Ammonia, which has a pungent odor, is commonly formed from organic nitrogen compounds during composting.
- Ammonium (NH₄⁺)** An ion of nitrogen and hydrogen. Ammonium is readily converted to and from ammonia depending on conditions in the compost pile.
- Anaerobic** An adjective describing an organism or process that does not require air or free oxygen.
- Anion** An atom or molecule with a negative charge (for example, nitrate, NO₃⁻).
- Aspergillus fumigatus** Species of fungus with spores that cause allergic reactions in some individuals. It can also cause complications for people with certain existing health problems.
- Availability, nutrient** See Nutrient availability.

Bacteria	A group of micro-organisms having single-celled or noncellular bodies. Bacteria generally appear as spheroid, rod-like, or curved entities, but occasionally appear as sheets, chains, or branched filaments.
Bedding	Dry absorbent material used to provide a dry lying surface for livestock. Bedding material, such as sawdust and straw, absorb moisture from livestock waste, the soil, and the environment.
Bin composting	A composting technique in which mixtures of material are composted in simple structures (bins) rather than freestanding piles. Bins are considered a form of in-vessel composting, but they generally are not totally enclosed. Many composting bins include a means of forced aeration.
Biochemical oxygen demand (BOD)	The quantity of oxygen used in the biochemical oxidation of organic matter in a specified time, at a specified temperature, and under specified conditions; normally 5 days at 20 degrees Celsius unless otherwise stated. A standard test used in assessing the biodegradable organic matter in municipal wastewater. See also Chemical oxygen demand.
BOD	See Biochemical oxygen demand.
Bucket loader	A vehicle that employs a hydraulically operated bucket to lift material. Includes farm tractors with bucket attachments, skid loaders, and large front-end loaders.
Bulk density	Weight or mass per unit of volume of a material made up of many individual particles. For example, the weight of a pile of wood chips divided by the volume of the pile is the bulk density. This is different from the particle density, which in this case equals the weight of a single wood chip divided by its volume). See also Density.
Bulking agent	An ingredient in a mixture of composting raw material included to improve the structure and porosity of the mix. A bulking agent is generally rigid and dry and often has large particles (for example, straw). The terms <i>bulking agent</i> and <i>amendment</i> are commonly used interchangeably. See also Composting amendment.
C	Chemical symbol for carbon.
Carbon dioxide (CO₂)	An inorganic gaseous compound of carbon and oxygen. Carbon dioxide is produced by the oxidation of organic carbon compounds during composting.
Carbon-to-nitrogen ratio (C:N ratio)	The ratio of the weight of organic carbon (C) to that of total nitrogen (N) in an organic material.
Cation	A atom or molecule that has a positive charge (for example, ammonium, NH ₄ ⁺).
Cellulose	A long chain of tightly bound sugar molecules that constitutes the chief part of the cell walls of plants.

Chemical oxygen demand (COD)	A measure of the oxygen-consuming capacity of inorganic and organic matter present in water or wastewater. It is expressed as the amount of oxygen consumed from a chemical oxidant in a specified test. It does not differentiate between stable and unstable organic matter and thus does not necessarily correlate with biochemical oxygen demand. See also Biochemical oxygen demand.
CO₂	Chemical symbol for carbon dioxide.
COD	See Chemical oxygen demand.
Compost	A group of organic residue or a mixture of organic residue and soil that has been piled, moistened, and allowed to undergo aerobic biological decomposition.
Composting	Biological degradation of organic matter under aerobic conditions to a relatively stable humus-like material called compost.
Composting amendment	An ingredient in a mixture of composting raw material included to improve the overall characteristics of the mix. Amendments often add carbon, dryness, or porosity to the mix.
Compost stability	See Stability of compost.
Contamination	Any introduction into the environment (water, air, or soil) of micro-organisms, chemicals, wastes, or wastewater in a concentration that makes the environment unfit for its intended use.
Cubic yard	A unit of measure equivalent to 27 cubic feet or 22 bushels. A box that is 1 yard wide, 1 yard long, and 1 yard high and has a volume of 1 cubic yard. A cubic yard is often loosely referred to as a <i>yard</i> (for example, a one-yard bucket).
Curing	Final stage of composting in which stabilization of the compost continues, but the rate of decomposition has slowed to a point where turning or forced aeration is no longer necessary. Curing generally occurs at lower, mesophilic temperatures.
Damping off disease	The wilting and early death of young seedlings caused by a variety of pathogens.
Decomposers	The micro-organisms and invertebrates that cause the normal degradation of natural organic materials.
Degradability	Term describing the ease and extent that a substance is decomposed by the composting process. Material that breaks down quickly and/or completely during the timeframe of composting is highly degradable. Material that resists biological decomposition is poorly degradable or even nondegradable.
Denitrification	An anaerobic biological process that converts nitrogen compounds to nitrogen gas or nitrous oxide.

Density	The weight or mass of a substance per unit of volume. See also Bulk density.
Endotoxin	Metabolic products of gram-negative bacteria that are part of the cell wall and will remain in the bacteria after it has died.
Enzymes	Any of numerous complex proteins produced by living cells to catalyze specific biochemical reactions.
Evaporative cooling	The cooling that occurs when heat from the air or compost pile material is used to evaporate water.
Forced aeration	Means of supplying air to a composting pile or vessel that relies on blowers to move air through the composting material.
Fungus (plural fungi)	A group of simple plants that lack a photosynthetic pigment. The individual cells have a nucleus surrounded by a membrane, and they may be linked together in long filaments called <i>hyphae</i> . The individual hyphae can grow together to form a visible body.
Gram-negative bacteria	Bacteria that test negative to the Gram stain procedure. The Gram stain procedure was originally developed by the Danish physician Hans Christian Gram to differentiate pneumococci for Klesbsiella pneumonia. The procedure involves the application of a solution of iodine to cells previously stained with crystal violet or gentian violet. This procedure produces purple iodine-dye complexes in the cytoplasm of bacteria. The cells that are previously stained with crystal violet and iodine are next treated with a decolorizing agent. The difference between Gram-positive and Gram-negative bacteria is in the permeability of the cell wall to these purple iodine-dye complexes when treated with the decolorizing solvent. While Gram-positive bacteria retain purple iodine-dye complexes after treatment with the decolorizing agent, Gram-negative bacteria do not.
Grinding	Operation that reduces the particle size of material. Grinding implies that particles are broken apart largely by smashing and crushing rather than tearing or slicing. See also Shredding.
Humus	The dark or black carbon-rich, relatively stable residue resulting from the decomposition of organic matter.
Hydrogen sulfide (H₂S)	A gas with the characteristic odor of rotten eggs, produced by anaerobic decomposition.
Immobilization, nitrogen	Conversion of nutrient compounds from an inorganic form, available to plants, into the organic tissue of micro-organisms (or other plants). The nutrients are unavailable until the micro-organisms die and the microbial tissues containing the nutrients decompose. Nitrogen immobilization occurs when material with a high C:N ratio is land applied. The micro-organisms that use the carbon also assimilate the available nitrogen, rendering it unavailable to plants.

Inoculum (plural inocula)	Living organisms or material containing living organisms (bacteria or other micro-organisms) that are added to initiate or accelerate a biological process (for example, biological seeding).
In-vessel composting	A diverse group of composting methods in which composting material is contained in a building, reactor, or vessel.
K	Chemical symbol for potassium.
Land application	Application of manure, sewage sludge, municipal wastewater, and industrial waste to land either for ultimate disposal or for reuse of the nutrients and organic matter for their fertilizer value.
Leachate	The liquid that results when water comes in contact with a solid and extracts material, either dissolved or suspended, from the solid.
Lignin	A substance that, together with cellulose, forms the woody cell walls of plants and the cementing material between them. Lignin is resistant to decomposition.
Liquid manure (thin slurry)	Manure that has had sufficient water added so that it can be pumped easily. Normally fibrous material, such as chopped straw or waste hay, is not present. See also Manure.
Litter, poultry	Dry absorbent bedding material, such as straw, sawdust, and wood shavings, that is spread on the floor of poultry barns to absorb and condition manure. Sometimes the manure-litter combination from the barn is also referred to as <i>litter</i> .
Manure	The fecal and urinary excretion of livestock and poultry. Sometimes referred to as livestock waste. This material may also contain bedding, spilled feed, water, or soil. It may also include waste not associated with livestock excrete, such as milking center wastewater, contaminated milk, hair, feathers, or other debris. See also Liquid manure, Semisolid manure, Slurry manure, and Solid manure.
Manure storage	A storage unit to keep manure contained for some period before its ultimate utilization or disposal. Manure storage is generally classified by type and form of manure stored and/or construction of the storage; for example, above- or below-ground liquid manure tank, earthen storage basin, or solid manure storage. See also Manure.
mho	See mmho.
Microbe	See Micro-organism.
Micro-organism	An organism requiring magnification for observation.

mmho (plural mmhos)	A millimho. One thousandth of a mho (pronounced mo with a long O). A mho is a unit of measurement for electrical conductivity that is the basis for measuring soluble salt concentration. (mho is the backward spelling of ohm, the unit of measurement for electrical resistance.)
Moisture content	The fraction or percentage of a substance made up of water. Moisture content equals the weight of the water part divided by the total weight (water plus dry matter part). Moisture content is sometimes reported on a dry basis. Dry-basis moisture content equals the weight of the water divided by the weight of the dry matter.
Mulch	A material spread over the soil surface to conserve moisture and porosity in the soil underneath and to suppress weed growth. Grass clippings, compost, wood chips, bark, sawdust, and straw are common mulch material.
N	Chemical symbol for nitrogen
Nitrate-nitrogen	A negatively charged ion made up of nitrogen and oxygen (NO_3^-). Nitrate is a water soluble and mobile form of nitrogen. Because of its negative charge, it is not strongly held by soil particles (also negative) and can be leached away.
Nitrification	The biochemical oxidation of ammonia nitrogen to nitrate.
Nutrient-holding capacity	The ability to absorb and retain nutrients so they are available to the roots of plants.
Organic matter	Chemical substances of animal or vegetable origin, consisting of hydrocarbons and their derivatives.
P	Chemical symbol for phosphorus.
Passive aeration	Air movement through composting windrows and piles that occurs by natural forces including convection, diffusion, wind, and the tendency of warm air to rise (thermal buoyancy).
Passive composting	Method of composting in which there is little management and manipulation of the materials after they are mixed and piled. Turning occurs infrequently (for example, monthly). Forced aeration is not provided.
Passively aerated windrow composting	A composting method in which windrows are constructed over a series of perforated plastic pipes that serve as air ducts for passive aeration. Windrows are not turned.
Pathogen	Any organism capable of producing disease or infection. Often found in waste material, most pathogens are killed by the high temperatures of the composting process.

Peat	Unconsolidated soil material consisting largely of organic matter accumulated under conditions of excessive moisture. The organic matter is not decomposed or is only slightly decomposed.
pH	A measure of the concentration of hydrogen ions in a solution. pH is expressed as a negative exponent. Thus, something that has a pH of 8 has 10 times fewer hydrogen ions than does something with a pH of 7. The lower the pH, the more hydrogen ions present and the more acidic the material is. The higher the pH, the fewer hydrogen ions present and the more basic it is. A pH of 7 is considered neutral.
Phytotoxic	An adjective describing a substance that has a toxic effect on plants. Immature or anaerobic compost may contain acids or alcohols that can harm seedlings or sensitive plants.
Pollution	The presence in a body of water (or soil or air) of a substance (pollutant) in such quantities that it impairs the body's usefulness or renders it offensive to the senses of sight, taste, or smell. In general, a public-health hazard may be created, but in some instances only economic or aesthetics is involved, as when foul odors pollute the air.
Porosity	A measure of the pore space of a material or pile of material. Porosity is equal to the volume of the pores divided by the total volume. In composting, the term porosity is sometimes used loosely, referring to the volume of the pores occupied by air only (without including the pore space occupied by water).
Poultry litter	See Litter, poultry.
Primary raw material (PRM)	See Primary substrate.
Primary substrate	The main waste material that requires treatment. Also called primary raw material.
Pythium	A fungal plant pathogen that causes seed, seedling, and root rots on many plants. These fungi are most active under conditions of high moisture.
Recipe	The ingredients and proportions used in blending together several raw materials for composting.
Redox potential	Oxidation and reduction (Redox) reactions are defined as reactions in which electrons are transferred. The species receiving electrons is reduced and the donating electron is oxidized. Redox reactions determine the mobility of many inorganic compounds as well as biologically important material such as nitrogen and sulfur. In addition, redox conditions govern the particulars for the biological degradation of complex carbonaceous material. Redox potential is an intensity parameter of overall redox reaction potential in the system similar to the concept of pH. Redox is not the capacity of the system for specific oxidation or reduction reactions.”
Root rot	A disease of plants characterized by discoloration and decay of the roots.

Saturated paste	A laboratory technique in which solid particles are rendered into a paste so that characteristics, such as pH and soluble salt concentration, can be measured.
Semi-solid manure	Manure that has had some bedding added or has received sufficient air drying to raise the solids content such that it will stack, but has a lower profile than solid manure and seepage may collect around the outside. It may be pumped with positive displacement pumps or handled with a front-end loader. See also Manure.
Sewage sludge	Solid part of waste from sewage treatment plants. Contains human waste.
Shredding	An operation that reduces the particle size of material. Shredding implies that the particles are broken apart by tearing and slicing. See also Grinding.
Slurry manure	Slurry manure has a near liquid consistency. It can be handled with conventional, centrifugal manure pumps and equipment, but the solids content may be too high for irrigation equipment. See also Manure.
Soil conditioner	A soil additive that stabilizes the soil, improves its resistance to erosion, increases its permeability to air and water, improves its texture and the resistance of its surface to crusting, makes it easier to cultivate, or otherwise improves its quality.
Soil structure	The combination or arrangement of primary soil particles into secondary particles, units, or peas. Compost helps bind primary soil particles to improve the structure of soil.
Solid manure	Manure that has had sufficient bedding or soil added or has received sufficient air drying to raise the solids content to where it will stack with little or no seepage. It is best handled with a front-end loader. See also Manure.
Stability of compost	The rate of change or decomposition of compost. Generally, stability refers to the lack of change or resistance to change. A stable compost continues to decompose slowly and has a low oxygen demand.
Stoichiometric oxygen	The oxygen proportioned in the exact right amount needed for, in the context of composting, biological degradation of organic matter under aerobic conditions.
Structure of composting mix or raw material	The ability to resist settling and compaction. Structure is improved by large, rigid particles.
Texture of composting mix or raw material	Characteristic that describes the available surface area of particles. A fine texture implies many small particles with a large combined surface area. A coarse texture implies large particles with less overall surface area.
Thermophilic	Heat-loving micro-organisms that thrive in and generate temperatures above 10 degrees Fahrenheit (40 °C).
Tipping fees	Fees charged for treating, handling, and/or disposing of waste material.

Turning	A composting operation that mixes and agitates material in a windrow pile or vessel. Its main aeration effect is to increase the porosity of the windrow to enhance passive aeration. It can be accomplished with bucket loaders or specially designed turning machines.
Vermin	Noxious or objectionable animals, insects, or other pests, especially those that are small; for example, rats, mice, and flies.
Volatile compound	A compound or substance that vaporizes (evaporates) at relatively low temperatures or is readily converted into a gaseous by-product. Examples include alcohols and ammonia. Volatile compounds are easily lost from the environment of a composting pile.
Windrow	A long, relatively narrow, and low pile. Windrows have a large, exposed surface area that encourages passive aeration and drying.
Yard waste	Leaves, grass clippings, yard trimmings, and other organic garden debris.

(Adapted from the On-Farm Composting Handbook, NRAES-54, Northeast Regional Agricultural Engineering Service Cooperative Extension.)

The list of materials appropriate for composting is almost endless. Only materials commonly available to farmers are described here and summarized as follows:

Bark	Paper mill sludge
Cardboard	Peat moss
Cattle manure	Poultry manure
Crop residue	Sawdust & shavings
Fertilizer & urea	Seaweed & other aquatic plants
Finished compost	Septage & sewer sludge
Fish processing wastes	Slaughterhouse & meatpacking waste
Food processing wastes	Spoiled hay & silage
Fruit & vegetable wastes	Straw
Grass clippings	Swine manure
Horse manure	Wood ash
Leaves	Wood chips
Lime	
Livestock manure	
Newspaper	

These materials are described here and are listed in table 2A-1 along with their characteristics (percent nitrogen, C:N ratio, moisture content, and bulk density).

Other materials abundant on the farm or available locally may be good components of a composting mix. Trucking raw materials beyond 50 miles is usually cost-prohibitive, so farmers should seek out local sources of clean organic materials. They should be evaluated in the same manner as the materials described below.

Cattle manure

Nitrogen-rich and very wet. Moisture content and C:N ratio depend on the amount of bedding used, management practices, type of operation, and climate. Generally requires a large amount of dry, high-carbon amendment (often two to three volumes of amendment per volume of manure). Relatively low odor risk if composted within a few weeks. Decomposes quickly. Bedded pack manure is moderately dry with a good C:N ratio. Liquid manure or slurries must be screened or dried unless only small amounts are used in the composting mix. Some trash may be present. Overall, a very good composting material.

Poultry manure

Very high nitrogen content and moderately moist. Needs a high carbon amendment. Litter with sawdust or wood shavings is well suited to composting and may be partly composted when removed from the barn. Nitrogen loss and odor from ammonia is a potential problem because of the high nitrogen content and high pH. Low pH amendments may be needed to lower the alkalinity. Decomposes quickly. The high nitrogen content can result in a fertilizer-grade compost. Good to very good composting material.

Horse manure

Usually contains large amounts of bedding; therefore, dry with a high C:N ratio. Composts well alone or as an amendment for wet cattle manure. Low odor potential. Decomposes quickly, especially if bedding is straw. Often available at little or no cost from local stables, racetracks, pleasure horse owners, fairs, and schools. Some stable wastes contain medication containers, soda cans, and other trash. Excellent composting material.

Swine manure

Nitrogen-rich and very wet. Needs a dry, high-carbon amendment. Strong potential for odors. High moisture content and odor make composting more difficult than other manure. With bedding, solids separation, and/or odor-control measures, it can be a fair to good composting material.

Other livestock manure

Sheep, goat, rabbit, and other livestock manure are usually good for composting. It is collected mostly from bedded manure packs and is, therefore, relatively dry with a high C:N ratio. Without bedding, the manure is nitrogen-rich and wet. Bedded material may be used as an amendment to other livestock manure. Relatively low odor potential. Decomposes quickly. Good composting material.

Crop residue

Variable characteristics depending upon the material, but generally moderate to high moisture and moderate C:N ratio. The C:N ratio and moisture content depend on the age and the amount of fruit and seeds present. Generally, older vegetation is drier and contains less nitrogen. Usually very good structure and good degradability. Some residue may be dry and high in carbon (cornstalks). Plant pathogens are a concern if

compost does not reach a high temperature in all parts of the pile. Excellent to good composting amendments, depending on the material.

Spoiled hay and silage

Moderately dry to wet, depending on conditions. Moderate to high C:N ratio. In most cases, available only occasionally. Added to compost mix as a disposal method and not as a reliable amendment. Good structure and degradability. Possible problems include odor and leachate from silage and weed seeds in hay. Moderate composting material.

Straw

Dry and carbonaceous. Good degradability. Provides very good structure and odor absorption. If used as bedding, it can precondition manure for composting. Availability and cost can be disadvantages. Excellent composting amendment.

Sawdust and shavings

Dry and carbonaceous. Moderate to poor degradability; sawdust degrades faster than shavings. Good moisture and odor absorption. Can also have a dual use as bedding. Usually available at a moderate to low cost. Good to moderate composting amendment.

Leaves

Relatively dry. High in carbon. Good degradability if shredded. Moderate moisture absorption. Low odor potential. Composts alone or as an amendment. Often contains trash, rocks, plastic bags, and so on—especially if collected from streets. Large quantities available, but seasonal supply requires storage and/or special handling and scheduling. Leaves can be obtained free, or a tipping fee may be available. Good to moderate composting material.

Wood chips

Dry and high in carbon. Large particle size provides excellent structure, but poor degradability. Often used as a bulking agent for forced aeration composting. Must be screened from final compost, but can be reused. Moderate to low cost. Has a competing use as a mulch product. Chips from preservative-treated and painted wood should not be used. Very good bulking agent, but poor amendment otherwise.

Bark

Qualities are similar to that of wood chips except for a given tree species, bark contains slightly more nitrogen and easily degradable compounds. May be composted alone for use in potting media or for mulch. Good bulking agent, but poor as a general amendment. Good material for specialty compost products (mulch, potting media) though the composting time is relatively long.

Grass clippings

Moderately wet to dry. Slightly low C:N ratio. Decompose quickly. Moderate to high odor potential depending upon management. Good source of nitrogen for leaf and yard waste mixtures. Usually available free, or a tipping fee may be available. Good composting material if mixed with coarse material. Alone, grass clippings tend to compact and become anaerobic.

Newspaper

Dry. High carbon content. Moderate degradability. Potential for dual use as bedding. Good moisture absorption, but poor structure and porosity. Black inks are generally nontoxic. Large quantities of colored inks and glossy paper are best avoided or should be analyzed because of possible heavy metals and other contaminants. Available in large quantities at little or no cost, or a tipping fee may be available. May need shredding and some sorting initially. Possible problems include storage, dust, and trash around the farmstead. In general, a good to moderate amendment depending upon the structure of the mix.

Cardboard

Dry and high carbon content. Good degradability. Good moisture absorption and structure. Large quantities available for little or no cost, or a tipping fee may be available. Shredding, storage, and some sorting may be needed. Staples in cardboard boxes may need to be removed. Glues in corrugated cardboard may contain high boron levels. Good to fair amendment.

Finished compost

Compost can be recycled as an amendment for wet wastes, either alone or in combination with other amendments. Moderately dry. Moderate to low C:N ratio. Provides a good initial supply of microorganisms. Frequent recycling may potentially lead to high salt concentrations, but otherwise no significant

disadvantages. Loss of compost product after recycling is small. Good amendment, especially for lowering the mix moisture content without raising the C:N ratio.

Peat moss

Acidic fibrous material that has resulted from years of anaerobic decomposition. Low in nitrogen. Highly absorbent of water, nutrients, and odors. May hold over 10 times its weight in water. Except in regions where natural deposits exist, peat moss is expensive partly because of its competing uses as an amendment for potted plants and other horticultural crops. Peat moss passes through the composting process virtually unchanged, producing potentially high valued compost. Its odor and water-absorbing qualities make it an excellent amendment, but cost limits its use.

Fruit and vegetable waste

Peels, tops, trimmings, culls, damaged or spoiled fruit. Moderate to wet with a moderate to low C:N ratio depending upon the nature of the waste. Except for pits, good degradability. Poor to fair structure. Standing piles of many fruits and some vegetable waste quickly collapse into a wet mess once decomposition begins. The potential for tipping fees exists. Slight to moderate risk of odor problems. Possible trash from packing operations and markets. Good to fair composting material.

Food processing waste

Variable characteristics depending upon the process. Filter press cakes generally are moderately dry and have high to moderate carbon content. Other food processing by-products are generally wet with moderate to low C:N ratios. Possible problems include high risk of odors, vermin (rats, mice, flies), contaminants from machinery and cleaning solutions used at the processing plant, and poorly degradable components, such as pressing aids. A major advantage is the opportunity to receive a tipping fee. Good to poor composting material depending upon the nature of the waste.

Slaughterhouse and meatpacking waste

Paunch manure, blood, miscellaneous parts. Wet and low C:N ratio. Good degradability. High risk of odors and vermin. More restrictive regulations may apply. Large amounts of amendment are required to lower moisture content and control odors. Except for paunch manure, composting should be considered

only if direct land application and other options are not practical.

Fish processing waste

Racks, frames, heads, tails, shells, gurry. Variable characteristics depending on waste, but generally moderately to very wet and high in nitrogen. Lobster, crab, shrimp, and mollusk shells provide good structure. All but mollusk shells decompose quickly. The high risk of odor along with the high moisture require large amounts of dry amendment and/or special handling. More restrictive regulations may apply. Potential for tipping fee. Wet material—racks or gurry—are troublesome, and composting should be considered after other options. Shells are moderate to good composting material if managed properly.

Seaweed and other aquatic plants

Water hyacinth, pond cleanings, wastewater treatment species. High to moderate moisture content, depending on previous drying. C:N ratios vary from low (seaweeds) to moderate (water hyacinth). Good degradability. Generally poor structure, especially for seaweeds. Good sources of minor nutrients, but salt content of seaweed is a possible problem if used in large quantities. Possible trash and weed seeds included with beach cleanings. Low to moderate odor risk. Good composting material with added structure.

Paper mill sludge

Wet or moderately wet if pressed. Moderate to high C:N ratio. Requires a dry amendment with nitrogen—a difficult combination. Good degradability, but poor structure. Slight to moderate risk of odor if mismanaged. Organic contaminants are occasionally found in paper sludge. Potential for tipping fee. Fair composting material.

Wood ash

Very dry with little or no carbon and nitrogen. Contains a fair amount of other nutrients, particularly potassium. The concentrations of heavy metals may be a concern with some ashes. In a composting mix, wood ash would absorb moisture and raise the pH of the mix. It has also been proposed as an odor-adsorbing agent. Handling is difficult as the ash is a fine powder that blows around and creates dust. Particles tend to cement together after they become wet. Tipping fees may be available. Fair to good composting amendment for wet acidic mixes. Should not be used if the pH is high.

Septage and sewage sludge

Raw and digested. Nitrogen-rich and very wet. Requires two to four volumes of dry amendment per volume of sludge. Septage and raw sludge decompose quickly, digested sludge moderately. Strong odor potential for septage and raw sludge, strong to moderate for digested. Possible contamination from human pathogens and heavy metals. Special regulations apply for pathogen reduction. Restrictions on land use apply for heavy metals. Composting this material usually involves operational and land application permits, process monitoring, and product analysis. The one advantage is the opportunity to collect a fee for composting this material. In general, sewage sludge and septage bring many restrictions and regulations. Though exceptions exist, it is best to avoid this material for farm composting operations.

Fertilizer and urea

Fertilizers, urea, or other concentrated nitrogen sources are sometimes considered as additives to lower the C:N ratio of high carbon material, such as leaves. Although such material does reduce the initial C:N ratio, the benefits are short-lived. Nitrogen from such sources tends to be available much more quickly than the carbon in the organic material. Initially, the available carbon and nitrogen are in balance; but as the easily available carbon is depleted, a surplus of nitrogen soon develops. Eventually, the excess nitrogen is lost as ammonia.

Lime

Like fertilizers, lime is also considered as an additive, either to adjust pH or to control odors. Generally, lime is an unnecessary ingredient and can be detrimental. pH adjustment is rarely necessary in composting. If lime is used for odor control, it can raise the pH enough to cause an excessive loss of ammonia. The same effects should be expected for other concentrated sources of alkalinity including cement kiln dust and wood ash.

Table 2A-1 Typical characteristics of selected raw materials

Material	Type of value	% N (dry weight)	C:N ratio (weight to weight)	Moisture content % (wet weight)	Bulk density (lb/yd ³)
Crop residue and fruit/vegetable-processing waste					
Apple filter cake	Typical	1.2	13	60	1,197
Apple pomace	Typical	1.1	48	88	1,559
Apple-processing sludge	Typical	2.8	7	59	1,411
Cocoa shells	Typical	2.3	22	8	798
Coffee grounds	Typical	--	20	--	--
Corn cobs	Range	0.4 – 0.8	56 – 123	9 – 18	--
	Average	0.6	98	15	557
Corn stalks	Typical	0.6 – 0.8	60 – 73 ^a	12	32
Cottonseed meal	Typical	7.7	7	--	--
Cranberry filter cake	Typical	2.8	31	50	1,021
(with rice hulls)	Typical	1.2	42	71	1,298
Cranberry plant (stems, leaves)	Typical	0.9	61	61	--
Cull potatoes	Typical	--	18	78	1,540
Fruit wastes	Range	0.9 – 2.6	20 – 49	62 – 88	--
	Average	1.4	40	80	--
Olive husks	Typical	1.2 – 1.5	30 – 35	8 – 10	--
Potato-processing sludge	Typical	--	28	75	1,570
Potato tops	Typical	1.5	25	--	--
Rice hulls	Range	0 – 0.4	113 – 1,120	7 – 12	185 – 219
	Average	0.3	121	14	202
Soybean meal	Typical	7.2 – 7.6	4 – 6	--	--
Tomato-processing waste	Typical	4.5	11 ^a	62	--
Vegetable produce	Typical	2.7	19	87	1,585
Vegetable wastes	Typical	2.5 – 4	11 – 13	--	--
Fish and meat processing					
Blood wastes (slaughterhouse waste and dried blood)	Typical	13 – 14	3 – 3.5	10 – 78	--
Crab and lobster wastes	Range	4.6 – 8.2	4.0 – 5.4	35 – 61	--
	Average	6.1	4.9	47	240
Fish-breading crumbs	Typical	2.0	28	10	--
Fish-processing sludge	Typical	6.8	5.2	94	--
Fish wastes (gurry, racks, and so on)	Range	6.5 – 14.2	2.6 – 5.0	50 – 81	--
	Average	10.6	3.6	76	--
Mixed slaughterhouse waste	Typical	7 – 10	2 – 4	--	--
Mussel wastes	Typical	3.6	2.2	63	--
Poultry carcasses	Typical	2.4 ^b	5	65	--
Paunch manure	Typical	1.8	20 – 30	80 – 85	1,460
Shrimp wastes	Typical	9.5	3.4	78	--

See footnotes at end of table.

Table 2A-1 Typical characteristics of selected raw materials—Continued

Material	Type of value	% N (dry weight)	C:N ratio (weight to weight)	Moisture content % (wet weight)	Bulk density (lb/yd ³)
Manure					
Broiler litter	Range	1.6 – 3.9	12 – 15 ^a	22 – 46	756 – 1,026
	Average	2.7	14 ^a	37	864
Cattle	Range	1.5 – 4.2	11 – 30	67 – 87	1,323 – 1,674
	Average	2.4	19	81	1,458
Dairy tiestall	Typical	2.7	18	79	--
Dairy freestall	Typical	3.7	13	83	--
Horse—general	Range	1.4 – 2.3	22 – 50	59 – 79	1,215 – 1,620
	Average	1.6	30	72	1,379
Horse—race track	Range	0.8 – 1.7	29 – 56	52 – 67	--
	Average	1.2	41	63	--
Laying hens	Range	4 – 10	3 – 10	62 – 75	1,377 – 1,620
	Average	8.0	6	69	1,479
Sheep	Range	1.3 – 3.9	13 – 20	60 – 75	--
	Average	2.7	16	69	--
Swine	Range	1.9 – 4.3	9 – 19	65 – 91	--
	Average	3.1	14	80	--
Turkey litter	Average	2.6	16 ^a	26	783
Municipal waste					
Garbage (food waste)	Typical	1.9 – 2.9	14 – 16	69	--
Night soil	Typical	5.5 – 6.5	6 – 10	--	--
Paper from domestic refuse	Typical	0.2 – 0.25	127 – 178	18 – 20	--
Pharmaceutical wastes	Typical	2.6	19	--	--
Refuse (mixed food, paper, etc.)	Typical	0.6 – 1.3	34 – 80	--	--
Sewage sludge	Range	2 – 6.9	5 – 16	72 – 84	1,075 – 1,750
	Activated sludge	Typical	5.6	6	--
Digested sludge	Typical	1.9	16	--	--
Straw, hay, silage					
Corn silage	Typical	1.2 – 1.4	38 – 43 ^a	65 – 68	--
Hay—general	Range	0.7 – 3.6	15 – 32	8 – 10	--
	Average	2.10	--	--	--
Hay—legume	Range	1.8 – 3.6	15 – 19	--	--
	Average	2.5	16	--	--
Hay—nonlegume	Range	0.7 – 2.5	--	--	--
	Average	1.3	32	--	--
Straw—general	Range	0.3 – 1.1	48 – 150	4 – 27	58 – 378
	Average	0.7	80	12	227
Straw—oat	Range	0.6-1.1	48-98	--	--
	Average	0.9	60	--	--
Straw—wheat	Range	0.3-0.5	100-150	--	--
	Average	0.4	127	--	--

See footnotes at end of table.

Table 2A-1 Typical characteristics of selected raw materials—Continued

Material	Type of value	% N (dry weight)	C:N ratio (weight to weight)	Moisture content % (wet weight)	Bulk density (lb/yd ³)
Wood and paper					
Bark—hardwoods	Range	0.10 – 0.41	116 – 436	--	--
	Average	0.241	223	--	--
Bark—softwoods	Range	0.04 – 0.39	131 – 1,285	--	--
	Average	0.14	496	--	--
Corrugated cardboard	Typical	0.10	563	8	259
Lumbermill waste	Typical	0.13	170	--	--
Newsprint	Typical	0.06 – 0.14	398 – 852	3 – 8	195 – 242
Paper fiber sludge	Typical	--	250	66	1,140
Paper mill sludge	Typical	0.56	54	81	--
Paper pulp	Typical	0.59	90	82	1,403
Sawdust	Range	0.06 – 0.8	200 – 750	19 – 65	350 – 450
	Average	0.24	442	39	410
Telephone books	Typical	0.7	772	6	250
Wood chips	Typical	--	--	--	445 – 620
Wood—hardwoods (chips, shavings, and so on)	Range	0.06 – 0.11	451 – 819	--	--
	Average	0.09	560	--	--
Wood—softwoods (chips, shavings, and so on)	Range	0.04 – 0.23	212 – 1,313	--	--
	Average	0.09	641	--	--
Yard waste and other vegetation					
Grass clippings	Range	2.0 – 6.0	9 – 25	--	--
	Average	3.4	17	82	--
Loose	Typical	--	--	--	300 – 400
	Compacted	Typical	--	--	500 – 800
Leaves	Range	0.5 – 1.3	40 – 80	--	--
	Average	0.9	54	38	--
Loose and dry	Typical	--	--	--	100 – 300
	Compacted and moist	Typical	--	--	400 – 500
Seaweed	Range	1.2 – 3.0	5 – 27	--	--
	Average	1.9	17	53	--
Shrub trimmings	Typical	1.0	53	15	429
Tree trimmings	Typical	3.1	16	70	1,296
Water hyacinth—fresh	Typical	--	20 – 30	93	405

a Estimated from ash or volatile solids data.

b Mostly organic nitrogen.

(Excerpted from On-Farm Composting Handbook, NRAES-54, Northeast Regional Agricultural Engineering Service Cooperative Extension)

A few characteristics of raw material and compost can be determined on the farm using simple procedures that require only available or inexpensive equipment. The characteristics include density, moisture, content, pH, and soluble salts. At a minimum, a good weighing scale is required. The scale should be able to read numbers that are at least one-hundredth the size of the sample (for example, 1/8 ounce for a 1-pound sample or 1 gram for a 100-gram sample). Scales that can read to 0.1 gram are preferable. Other equipment required depends on the specific test.

Laboratory safety

The tests described here are not hazardous, but a few simple safety precautions need to be observed. Gloves should be available and worn when hot containers are handled. Safety glasses or goggles should also be available. Work areas should be well vented. Observe appropriate equipment precautions. For example, do not use metal containers in a microwave oven and do not leave a microwave oven unattended while samples are being heated.

Samples

The first step in testing material is obtaining a representative sample. The sample should reflect the overall qualities of the material being tested. It is best to collect many samples from different locations in a pile and/or from several piles. Mix these samples and then draw subsamples to be tested from the mixture. If a single sample is taken, collect it from a location that is typical of the whole pile. Avoid taking samples from the center, edge, and outer surface. These areas are more likely to have different qualities from the bulk of the material in the pile.

Samples can lose moisture and undergo other changes in the time that elapses between collecting and testing material. Therefore, samples should be collected shortly before testing. If they must be collected some time in advance, they should be refrigerated in a covered container or at least kept away from heat, sunlight, and other conditions that might alter their characteristics.

The sample size should be convenient to work with and suited to the testing equipment and containers. Establish a standard sample size so that testing procedures are consistent. The calculations can sometimes be simplified by using samples sizes that have round numbers, such as 100 grams, 1 pound, or 1 liter, then weighing the dried sample. In general, the larger the sample is, the more accurate the testing results will be. However, this must be balanced with practicality. For example, larger samples take a longer time to dry for moisture content determinations.

Density

Density is calculated by dividing the weight of a substance by the volume that it occupies. In composting work, a material's bulk density generally is required. Bulk density is the mass of a pile or container of material divided by the volume of the pile or container. The volume includes the air spaces between particles. For example, the density of a pile of wood chips (bulk density) is more important to know than the density of an individual wood chip (particle density).

Density can be determined by filling a container of known volume and weight with the material to be tested and then weighing the filled container. The density equals the filled container weight minus the empty container weight divided by the container volume.

$$\text{Density} = \frac{(\text{filled container wt} - \text{empty container wt})}{\text{container volume}}$$

When determining the bulk density, the material needs to fill the container with nearly the same degree of compaction that occurs in the storage or field stack. It must not be packed down; otherwise, the bulk density will be overestimated. Filling the container properly can be tricky; therefore, it is best to obtain and weigh several samples and then average the results.

Moisture content

Moisture content is the portion of a material's total weight that is water. It is often expressed as a percentage. The nonwater portion of a material is referred to as dry matter.

Moisture content can be determined by drying a sample of material to remove the water and then weighing the dried sample. Follow these steps:

1. Weigh the container.
2. Weigh the wet sample and the container.
3. Dry the sample (see sections on drying below).
4. Weigh the dried sample and container.
5. Subtract the dried weight from the wet weight and determine the moisture content, as explained below.

The difference between the wet weight and dried weight is the weight of water removed from the sample. The moisture content equals the weight of water removed (that is, wet weight of the sample minus its dry weight) divided by the wet weight minus the weight of the container. Note that this is the wet-basis moisture content. The moisture content on a dry basis is the wet weight minus dry weight divided by the dry weight minus the container weight. To obtain the moisture content in percent, multiply this ratio by 100:

$$\text{Moisture content (\%)} = \left(\frac{\text{wet wt} - \text{dry wt}}{\text{wet wt} - \text{container wt}} \right) \times 100$$

Where the wet weight is the total weight of the sample including the container.

The goal in drying a sample is to remove the water while minimizing the loss of *volatile* dry matter compounds, such as ammonia and organic acids. Samples are dried at a relatively low temperature over a long period because high temperatures increase the dry matter loss, especially if a sample burns. There is a tradeoff between accuracy and speed. Lower temperatures and larger samples generally improve accuracy, but increase drying time.

The general procedure involves weighing the wet sample and then drying it until the sample no longer loses weight. To determine this, the sample must be dried in stages and then weighed after each stage. The sample is dry when its weight remains constant between two consecutive drying stages. For composting purposes, the sample can be considered dry if its weight changes by less than 1 percent of the original wet weight (for example, 1 gram for a 100-gram sample). The required drying time varies with the temperature, drying equipment, sample size, and sample moisture. After a number of experiments,

typical drying times can be established. The general guidelines that follow provide a starting point, but experimentation is still necessary to establish routine procedures for specific equipment and sample characteristics.

Methods for determining moisture content on the farm differ in the way that the sample is dried. Three common methods include air drying, conventional oven drying, and microwave oven drying. Although the results produced by these methods are less accurate than laboratory procedures, they are satisfactory for almost all composting situations.

Air-drying is perhaps the simplest method for determining the moisture of a sample. First obtain the weight of the sample container and then weigh the container full of material. The larger the sample, the more accurate the results (that is, a gallon sample is more accurate than a pint sample). Next, spread the sample material no more than 0.5-inch-thick on paper in a warm room that has a fan to improve air circulation. Allow the sample to dry for 24 to 48 hours, stirring occasionally to obtain uniform drying of all particles. Pour the material back into the sample container and weigh again. It may be necessary to repeat these steps, weighing every several hours, until the weight loss is negligible. Air-drying removes most, but not all, of the water in the sample material; therefore, the actual moisture content tends to be underestimated. However, for most composting situations, air-drying produces acceptable moisture content estimates.

Samples can be more thoroughly dried in a conventional heated-air oven at temperatures between 140 and 220 degrees Fahrenheit. An oven temperature of 212 degrees Fahrenheit is a good compromise between speed and accuracy for most composting material. Rough estimates for drying a 4-ounce (100-gram) sample range from 24 hours (219 °F) to 72 hours (141 °F). Experimentation and periodic weighing are necessary to determine the required time for a given temperature and sample material. Drying can be quickened by spreading the sample in a thin layer.

Drying time is considerably reduced by using a microwave oven to dry samples. Again, experimentation is necessary to determine the drying time for a given microwave oven and sample. As a start, use a 4-ounce (100-gram) sample of moist material and heat it for 8

minutes at full power in a microwave oven with at least 600 watts of power. For a less powerful microwave oven, increase the heating period (or reduce the sample size). For relatively dry material, such as finished compost, decrease the heating period to 6 minutes. After this initial heating, remove the sample from the oven and weigh it. Then reheat the sample for another 2 minutes, rotating it 90 degrees from its original position when replacing it in the oven. After reheating, weigh the sample again. Continue the cycle of heating and weighing at 1-minute intervals until the weight change is negligible. If you notice the sample becomes burned or charred, start a new trial using less power and/or shorter heating times. After determining the required drying time for a particular microwave oven, sample size, and material, a continuous drying period can be used.

Microwave drying is a convenient and relatively accurate method of determining moisture content; however, care must be taken to avoid overheating and spot burning of the sample. Spreading the sample in a thin layer is helpful. Samples must be placed in microwave safe containers. Metal should not be placed in a microwave oven. A paper plate is a good container because it is light weight and the sample can be spread. For maximum accuracy, paper containers should be preheated to remove moisture.

pH and soluble salts

Saturated paste method—This method is the most common and reproducible method used for measuring pH and soluble salts. This method can be mastered by almost anyone because it is simple and requires easily available supplies. The equipment needed includes a pH meter and a solubridge meter. Simple battery operated pH and solubridge meters are available at reasonable costs, and they are easy to operate.

Because compost is rich in ammonium, the solutions used for preparing samples for measuring pH and soluble salts are different. Therefore, separate preparations must be made for each measurement. When measuring pH, use only a 0.01 M solution of calcium chloride. This is equivalent to approximately a slightly rounded teaspoon of U.S.P. grade calcium chloride dissolved into a gallon of distilled or deionized water. For measuring soluble salt, use either distilled or deionized water alone, without calcium chloride.

To make a saturated paste, use a paper or plastic drinking cup half filled with compost. Depending on which test you are conducting, add the appropriate solution in small quantities and stir constantly with a stirring spatula, kitchen knife, or plastic plant label. A saturated paste is achieved when there is just enough water to make a smooth paste of the compost so that when the cup is held in a horizontal position, all of the water will be held by the compost and none will flow to the sides of the cup. This mixture should be allowed to stand with the container covered at room temperature for at least 4 hours, preferably overnight, before measurements are taken. Just before taking measurements, stir the saturated paste. If it appears to have dried, either the distilled or deionized water or the calcium chloride solution must be added before measuring. If several samples are being tested, remember to rinse your stirring tool before stirring the next sample. The measurements are taken by plunging the base of the instruments into the saturated paste and taking readings as soon as the numbers stabilize.

